

COMBINED PROTECTOR MANUALS

2) Protector P70

22) Protector P40

42) Protector P25

62) Protector P10

PROTECTOR P70 MANUAL



WWW.IWTM-UK.COM
T: +44 208 255 2903
E: INFO@IWTM-UK.COM

TABLE OF CONTENTS

03	DESCRIPTION & FEATURES
05	INSTALLATION
08	DATA & MEASUREMENTS
10	MAINTENANCE
16	ACCESSORIES
17	VALVE KIT
18	SERVICE JOURNAL

DESCRIPTION & FEATURES

WHAT IS PROTECTOR P70?

Protector P70 is a model from our IWTM Protector™ range, a unique side stream filtration device that engineers the system water to a non-corrosive state.

It provides corrosion protection in both new and existing heating and cooling systems, by removing sludge, particles, oxygen and other corrosive products. Therefore the system is maintained in the best possible way, by constantly filtering and engineering the water using electrochemistry and anode technology. The result is that its cleaning and engineering the water at the same time.

NEXT GENERATION OF ELECTROCHEMISTRY

The units provide faster clean-up of old systems and quicker compliance with pre commissioning targets on new systems due to the higher flow rates through the reaction tank (cathode) and the inbuilt ss micron filter that enables finer filtration. The unscreened larger anodes last longer and release the magnesium hydroxide quicker for faster pH control. Compliance with VDI 2035 is still obtained as the anodes sit inside the ss micron filter to capture the magnesium residue when the anodes expire.

- Protector is an "all in one solution"
- Controls the three key parameters of VDI 2035 ; pH, conductivity & dissolved oxygen.
- Creates a hostile environment for bacteria
- Keeps the water clean in closed circulation systems and removes all particles and impurities

In closed systems typical installation will be in side stream but it can also be installed in the main flow in a modular arrangement for larger systems. This provides a method of easy installation, operation and maintenance.

PARTICLE FILTRATION

Protector P70 comes as standard with a robust stainless steel micron filter which is 40 micron nominal. The stainless steel AISI 316, 40µm filter has a large surface which gives a long operating time before cleaning and thus less flushing and refilling.

Please note: The 40 micron stainless steel filter supplied with the Protector as standard although robust in its manufacturing is a consumable item.

It's life expectancy is dependent on the harsh environment it has to deal with when being used to clean existing systems and therefore is not covered by any warranty. On a new system it is possible that the filter can last for many years, but on clean-up project it may only last for a few months.



2-Layer S.S Filter

DESCRIPTION & FEATURES

NEODYMIUM MAGNETS

One long, dry, powerful magnet is mounted in the centre of the ss micron filter and in front of the sacrificial anodes so that magnetite is captured and not deposited on the anodes, also preventing the ss micron filter from clogging up with magnetite. This provides longer service intervals as well as increased operational life and better function. When the magnet is lifted out, all magnetite will be released and can be drained out.

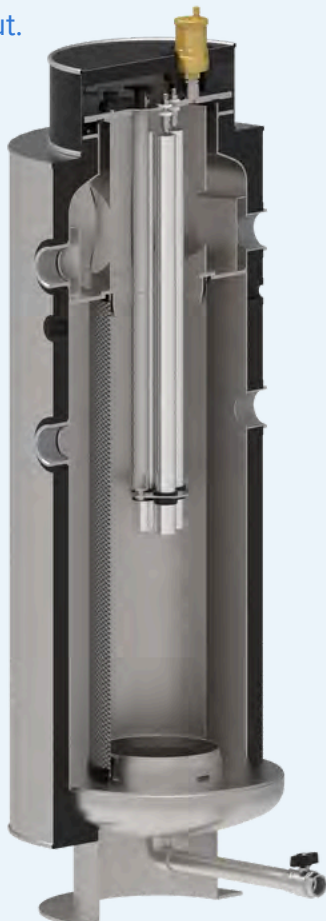

SACRIFICIAL ANODES

Magnesium anodes that provide anodic water treatment and lower the fluid's conductivity.

The anodes also scavenge oxygen and regulate the pH level.

For longer life expectancy, the anodes are encapsulated by a stainless steel ss micron filter, removing the need for individual anode screens.

INSTALLATION



For larger volume systems, installation in series is possible.

SIDE STREAM INSTALLATION

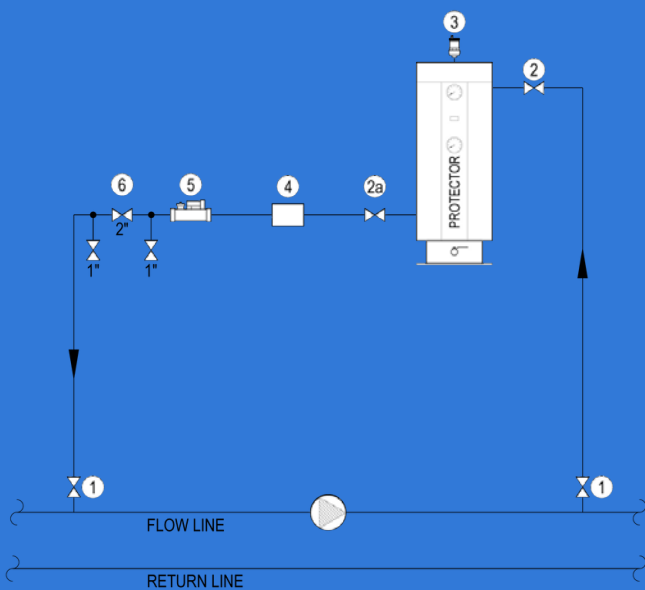

KEY

- 1. CLIENT IV's NOT SUPPLIED
- 2. DRAIN COCK LEVER IV MALE & FEMALE
- 2a. LEVER IV MALE & FEMALE
- 3. 551 CALEFFI UNIT AIR VENT
- 4. MECHANICAL WATER METER
- 5. FLOW REGULATOR
- 6. FLUSHING BY-PASS FOR RESIN RINSING

Protector P70 is to be mounted in a “bypass” installation over an existing circulation pump. (Separate circulation pump can be used if needed.)

-Pressure side on pump should be to the inlet on Protector P70 unit.

-Suction side on pump should be to the outlet on Protector P70 unit.

INSTALLING CONNECTIONS

- 2 pc 1” Female Connections (inlet / outlet)
- 2 pc 2” Plugs (for connections not in use.)
- 2 pc 2” Ball valves
- 2 pc 2” Plugs
- 1 pc 2” Flowmeter
- 1 pc 2” Regulating Valve
- 1 pc 1/2” Air Vent
- 1 pc 2” Drain Valve
- 1 Test Point Valve

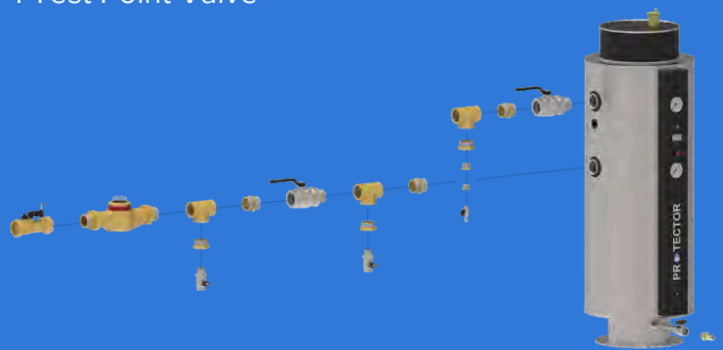

Ensure that 1000mm clearance is left above the Protector AAV.

Ensure that 600mm clearance is left in front.

INSTALLATION

SIDE STREAM INSTALLATION USING OWN PUMP

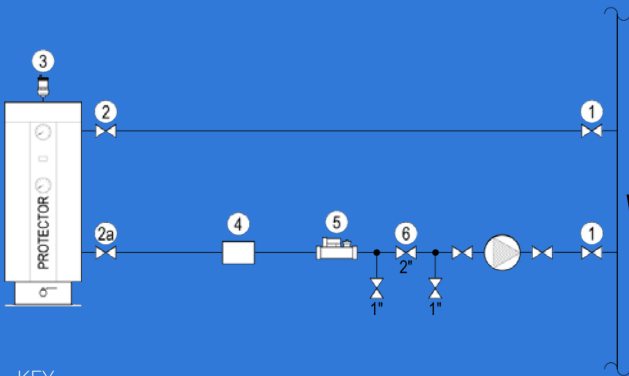

KEY

- 1. CLIENT IV's NOT SUPPLIED
- 2. DRAIN COCK LEVER IV MALE & FEMALE
- 2a. LEVER IV MALE & FEMALE
- 3. 551 CALEFFI UNIT AIR VENT
- 4. MECHANICAL WATER METER
- 5. FLOW REGULATOR
- 6. FLUSHING BY-PASS FOR RESIN RINSING

Connections:

Can be connected:

- IN from either left or right. (only on the top)
- OUT from left or right. (only on the bottom)

-Connections not in use, to be plugged. (1" female threads)

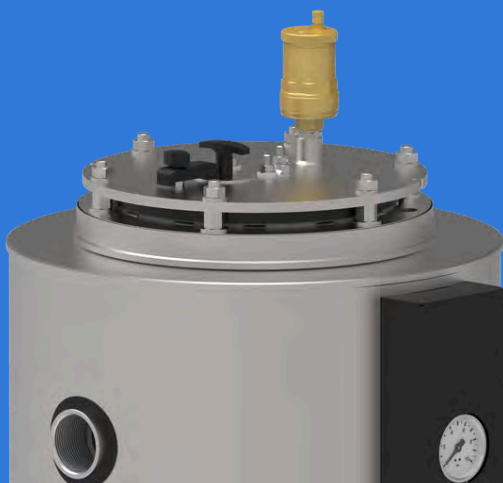

INSTALLATION

INSTALLATION & COMMISSIONING INSTRUCTIONS

- Close the outlet valve.
- Keeping outlet closed whilst opening the inlet valve.
- Open the automatic air vent.
- Fill the Protector unit the automatic air vent has dispensed all of the air.
- Open the outlet valve so water flows through the Protector.
- Check the water meter is rotating.
- Set regulating valve as below:

Isolation and Flow Regulation:

The valve can be operated from fully closed to fully open..

A slot on the end of the control stem indicates the status of the valve.

When the control stem is turned fully clockwise and the slot lies perpendicular to the axis of the valve, the valve is fully closed.

When the control stem is turned fully anti-clockwise and the slot lies in line with the axis of the valve, the valve is fully open.

altecnic
CALEFFI group

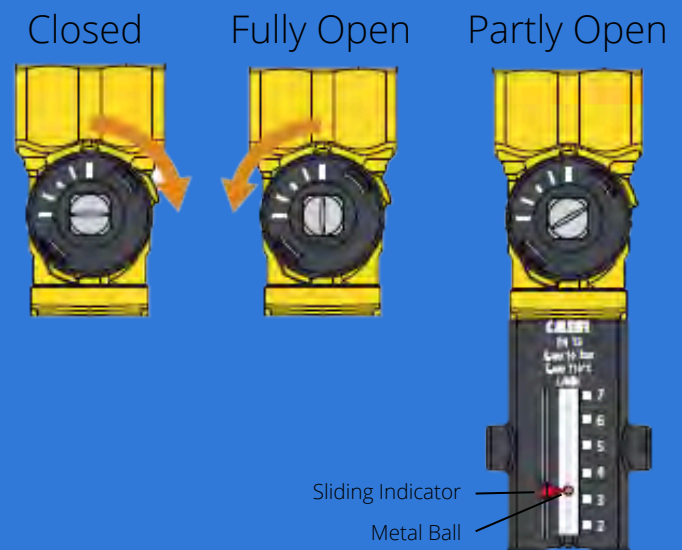

To regulate the flow, firstly with the aid of the sliding indicator, mark the reference flow rate to which the valve requires setting.

Using a suitably sized spanner on the operating square of the control stem of the valve rotate until the design flow rate is achieved.

This is indicated by the metal ball that runs inside the transparent guide.

- Record the water meter reading

DATA & MEASUREMENTS

PROTECTOR P70 DATA

System Volume: Heating -Max. 70m³

Cooling - Max 60m³

Flow: 70l/min

Empty Weight: 88KG

Full Weight: 218KG

Shipping Weight: 157KG

Design Pressure – PN10

Max Temperature - 95°C

Volume of Unit - 130L

Design Code – PED 2014/68/EU

Connection - 2" female thread / BSP

MATERIALS

Filter House: Stainless steel AISI 304

SS Micron Filter: Stainless steel AISI 316L

Gasket: EPDM

Insulation/Mantling: Armaflex /stainless steel

Manometer: Stainless steel AISI 304

Anodes: Magnesium with filter AISI 304

Magnet: Neodymium

Surface treatment: Brushed Stainless Steel

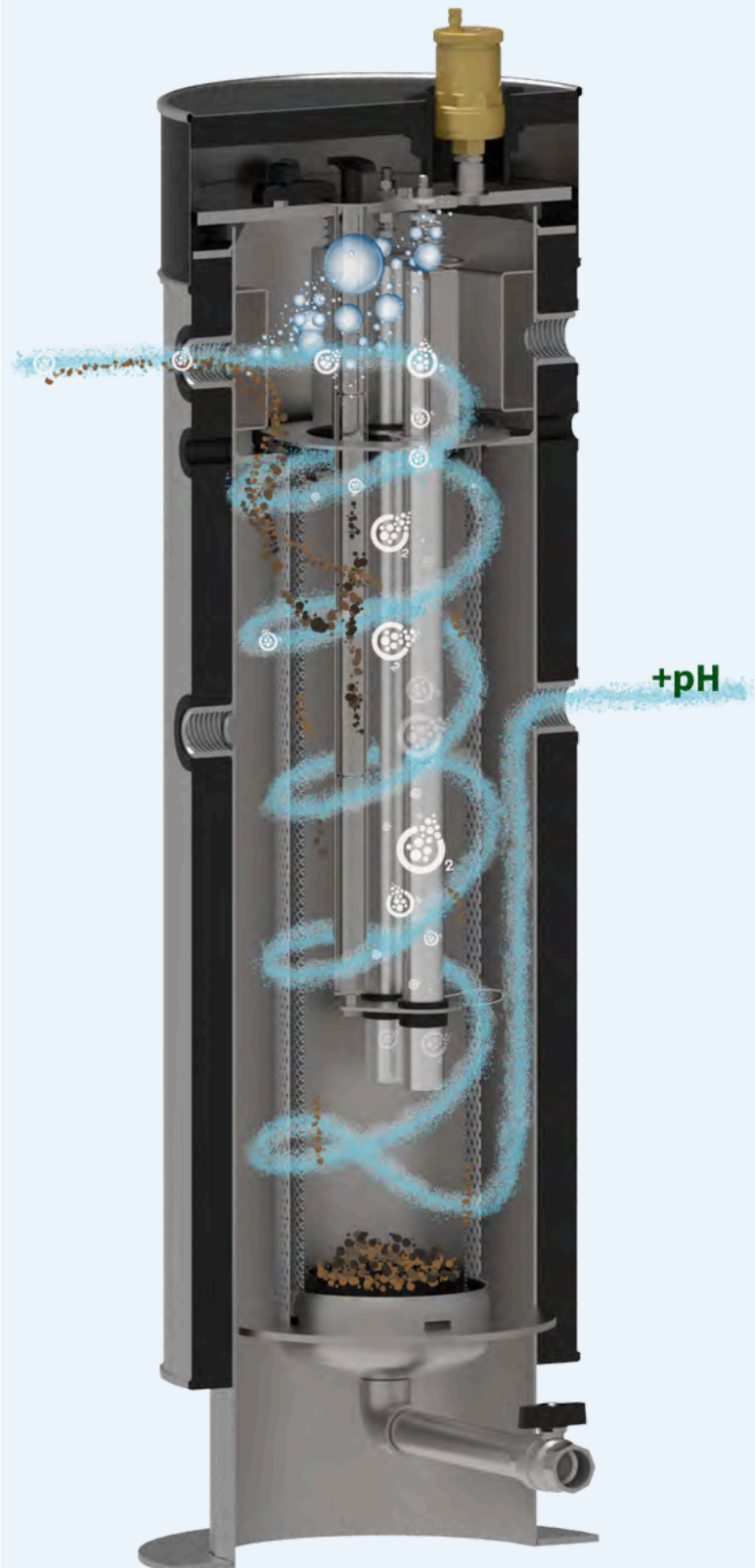

Note: Talk to us for systems that operate at higher pressures or higher temperatures.

DATA & MEASUREMENTS

PROTECTOR P70 MEASUREMENTS

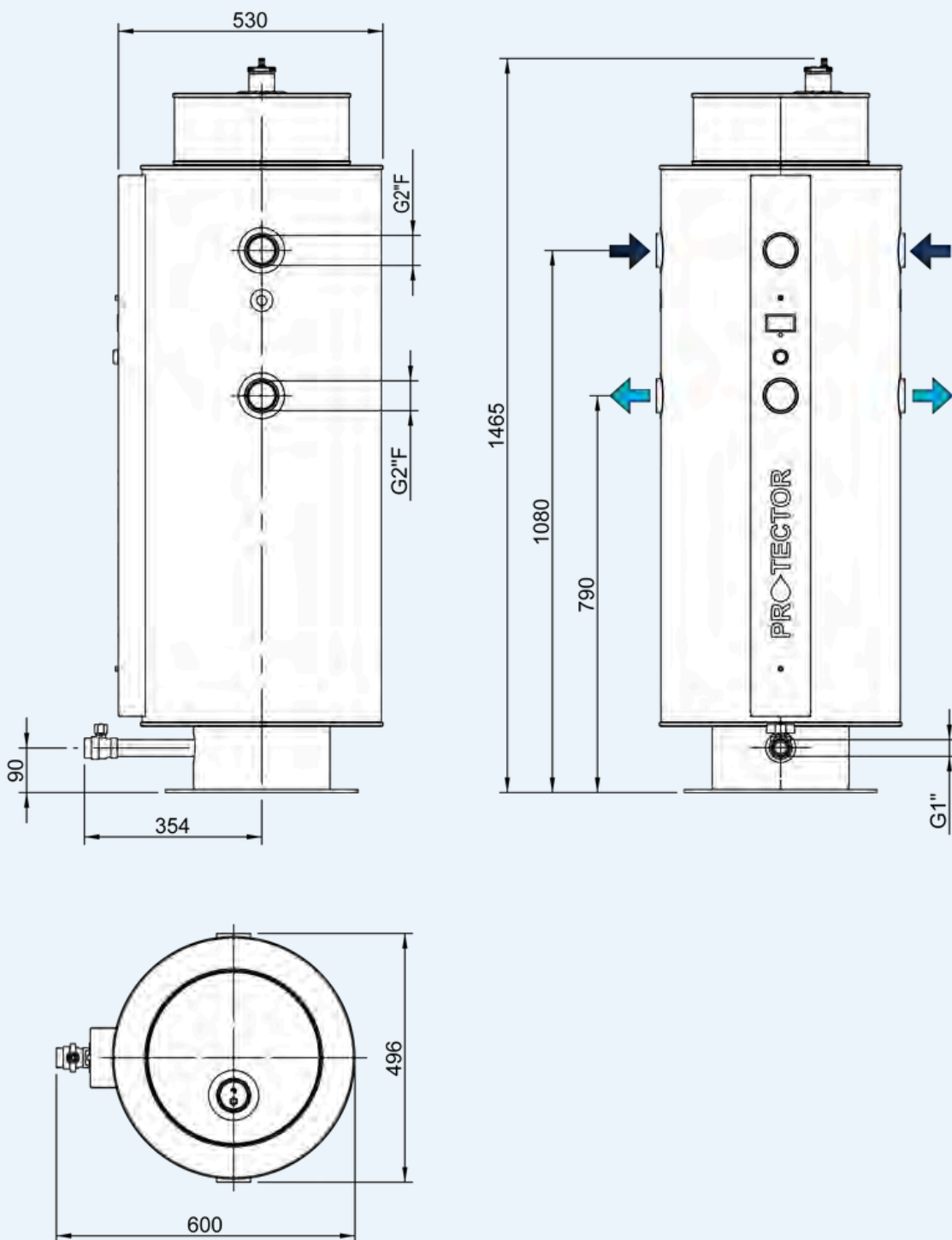

MAINTENANCE

DRAINING

The Protector P70 unit needs to be drained frequently ; how often is dependent on the water quality.

The higher the starting conductivity level, the more sludge there'll be, resulting in a need for more frequent draining.

This is to flush out the sludge and particles that have been collected in the bottom of the tank, from the magnet trap and the ss micron filter.

The one piece long magnet in the Protector P70 is inserted on top of the tank on the flange lid.

- Close the inlet to the Protector P70.
- Pull out the magnet on top of tank.
- Open the drain valve in the bottom of tank and flush until the water is running clear of debris.
- When complete, close the drain valve and put the magnet back in the sleeve.

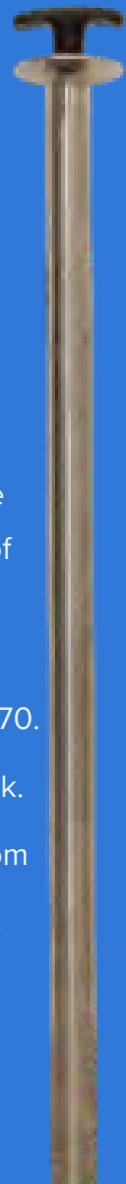

MAINTENANCE

ANALOGUE GALVANOMETER & PUSH BUTTON

The analogue galvanometer shows the galvanic current in milliamps between the anodes and the cathode (the tank body), with the system water being the medium.

The analogue galvanometer is always in a continuous reading position ; when the switch is pressed, the instrument is short circuited and shows little or no reading. This function is only for testing the analogue meter itself.

Pure water is non conducting, therefore the more impurities and oxygen in the water the more current will flow between the anode and the cathode.

When the water quality improves, the current diminishes and may measure even as low as 0.2 to 0.3 milliamps when the system water is fully passive.

The Protector P70 system is self-regulating, the anode automatically works harder with corrosive water than with water that is no longer reactive.



The needle swing lies between 10% and 100%.

This is the normal operating region. The lower the reading, the less the anode needs to work, and the less impurities are in the system water.

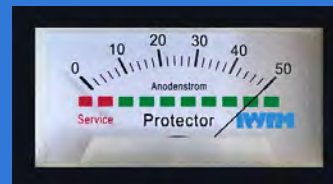

The needle always reads 100%.

The anode is working hard.

If the needle remains in this position for longer than one heating season, the Protector P70 may be undersized for the system.

Action: check the system volume

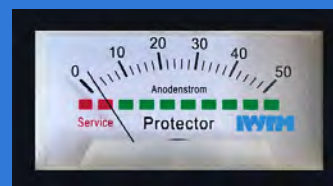

The needle lies continuously close to the red region ;

the needle still drops

to the minimum reading when you press the test button however, the anode no longer needs to work because the chemical reactions in the water have finished, the anode can no longer work because it is coated in a barrier layer or the anode may be close to expiring and needs replacing.

MAINTENANCE

ANALOGUE GALVANOMETER & PUSH BUTTON

Action: remove the sludge from the Protector P70 and fill with fresh water. Keep the isolation valves closed for a day to hold the more corrosive fresh water inside the Protector P70.

After a day, if the operating meter shows a higher reading, everything is operating correctly, and the Protector Master can be put back into operation. Otherwise, you need to open the lid to inspect the appliance.

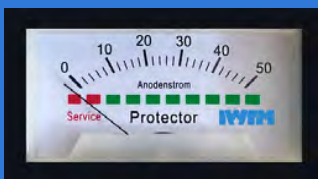

The needle drops into the red region within a few weeks.

The anode is spent or coated in a barrier layer or the Protector is isolated from the system and no water is circulating through it.

Action: check circulation or open the appliance and clean or replace the anodes.

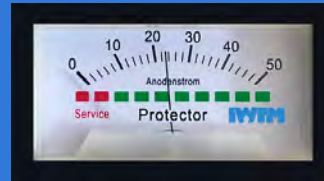

The meter continues to show a constant reading over a long period.

The operating meter might be faulty.

Action: press the test button to check the meter (the needle should drop to the left).

If there is no change in the needle position, the meter is probably faulty.

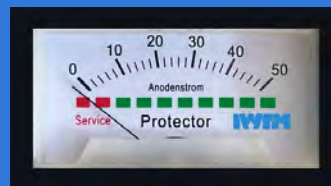

After servicing, if the indicator position is hard left in the red.

If the anode wires are connected wrong, it will create a short circuit and the swing meter will sit in the red zone and will raise up slightly when pressing the test button. Action: change the two connection wires around on the anode and the earth.

While the Protector P70 is increasing the pH and scavenging oxygen the water gets less aggressive and the current will decrease and stabilise. (normally from 4-15 mA). If some chlorides or sulphates should interfere, resulting in higher conductivity or increased oxygen (feed water), the ampere & output will increase again.

MAINTENANCE

MAGNESIUM ANODES

The filter anodes are in a basket of stainless steel wire mesh called the ss micron filter and do not normally need any cleaning, if however, they are coated in slime from chemical residue or any other debris this can be removed with a suitable scraper to get back to the bare anode surface. Check the anodes for proper functioning (mA instrument).



TOOLS:

- Isolating nut dry side 13 mm spanner
- Isolating bolt wet side 17 mm spanner
- Anode bolt 10 mm spanner
- Flange cover nuts 19 mm spanner

SERVICE

Service on the Protector unit should be done once a year. However, this is also depending upon the quality of the system water.

If there has been an existing problem with sludge, sediments etc. before the Protector installation, we recommend a first service after 3 months of operation. It's also important to take a water sample out of the system, for analysis in a laboratory.

The isolation screw going through the flange has two nylon washers one on each side of the flange. Once opened, they **cannot** be reused. These washers are not part of the replacement kit. So please do not undo the isolation screw.

Make sure not to rotate the bolt while changing the anode. Use a 17mm spanner to hold the isolation bolt securely whilst removing/fitting the anode bolt with a 10mm spanner. This will ensure the isolation screw does not turn. Once the anode has been replaced, use a test meter to check there is no continuity between the anode & the flange. The two isolation washers have two functions 1. To create a watertight seal 2. To electrically isolate the anode from the tank.

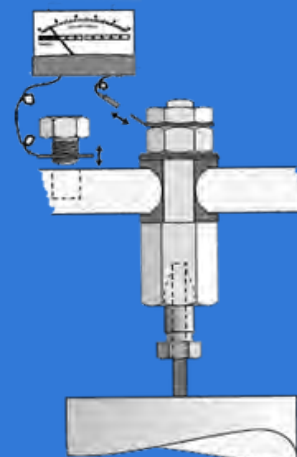

MAINTENANCE

SERVICE

- Close the inlet and outlet ball valves.
- Unscrew the air vent and empty the tank through the drain valve.
- Unscrew the flange lid.
- Carefully lift up the lid, the anodes are attached to the underside.
- Check the anodes and the magnesium rods.
- Flush the anodes, if the magnesium is below 10mm diameter, replace with new ones.
- Take out the ss micron filter and flush / clean.
- Clean the tank inside using a hose or a pressure gun.
- Check all parts belonging to the Protector Master and clean them if required. (AAV flowmeter, reg. Valve etc.)

When replacing the anode hold the isolation screw going through the flange and unscrew only the small inner screw at the end of the steel core of the anode. After mounting a new anode, make sure that all screws are tight and that the electrical wiring is properly reinstalled. If there's no indication on the meter, the Protector P70 is not working.

When done, put everything back in place and fill up the Protector P70 on the inlet. When the air vent stops letting out air, the tank is refilled and you can open the outlet and start the circulation again. Check that the flowmeter is running.

1)



2)



3)

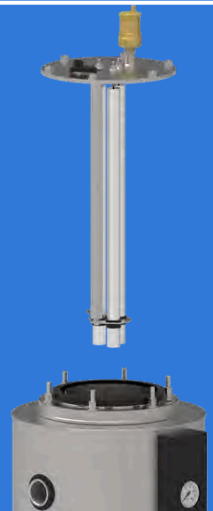

4)



5)

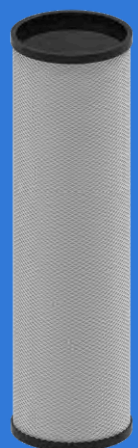

MAINTENANCE

PARTICLE FILTER

Inside the Protector P70 unit is installed a ss micron filter, to catch and remove all sediments and particles.

- The ss micron filter is locked with a small metal clip in the bottom.
- Just twist the ss micron filter slightly to the top left and lift it out.
- Clean the ss micron filter with a water hose.
- Make sure all particles are removed from the ss micron filter.

When done just put it back, turn it slightly to the right and its locked again.

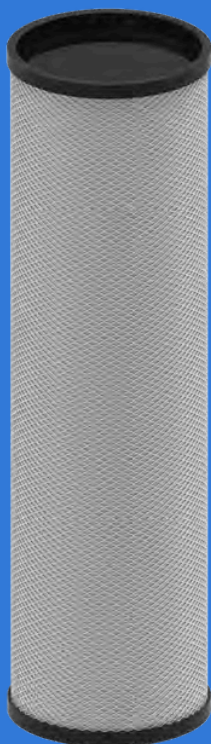

(AISI 316 with
40µm ss micron
filter.)



ACCESSORIES

Part No.	Description
Protector - Complete Units	
FZPRBG035	PROTECTOR P70 ANALOG 2" F WITH UK VALVE KIT
Protector - Filtering Elements	
AMCRT0048	2 LAYER INOX SS MICRON FILTER SIZE 11, 40MM
Protector - Spare Parts	
CDGRN0005	HOUSING GASKET Ø273 (EPDM)
CDGRN0017	BAG HOLDER GASKET (EPDM)
101565	ANODE SET NO MESH- PROTECTOR P70
CASCM0015	AIR VENT
100078	ANALOG INDICATOR



VALVE KIT

The Protector P70 is supplied with the following valve kit which is packed inside the main Protector P70 box.



Environmental Culture Change

be a part of it

clean | protect | prevent





Founded in 1992, IWTM have been working with chemical free water treatment using electrochemistry for over 30 years and have offices in Norway, UK, Finland, Sweden, Canada, USA and a worldwide presence in the Marine sector.

We have developed models specifically suited to the higher demands of the marine industry operating at higher pressures and higher temperatures. The marine products are provided worldwide on the world's largest cruise ships working with the leading operators in this sector.

Having secured DNV approval in 2003, we are still the only chemical free water treatment manufacturer to have this certification and approval. DNV is a globally leading quality assurance and risk management company operating in more than 100 countries.

The IWTM Protector™ is our most recently developed product. The Protector range is now available to our land-based customers.

Version 7: June 2024

In line with continued product development we reserve the right to make any changes to this document without any given notice.

PROTECTOR

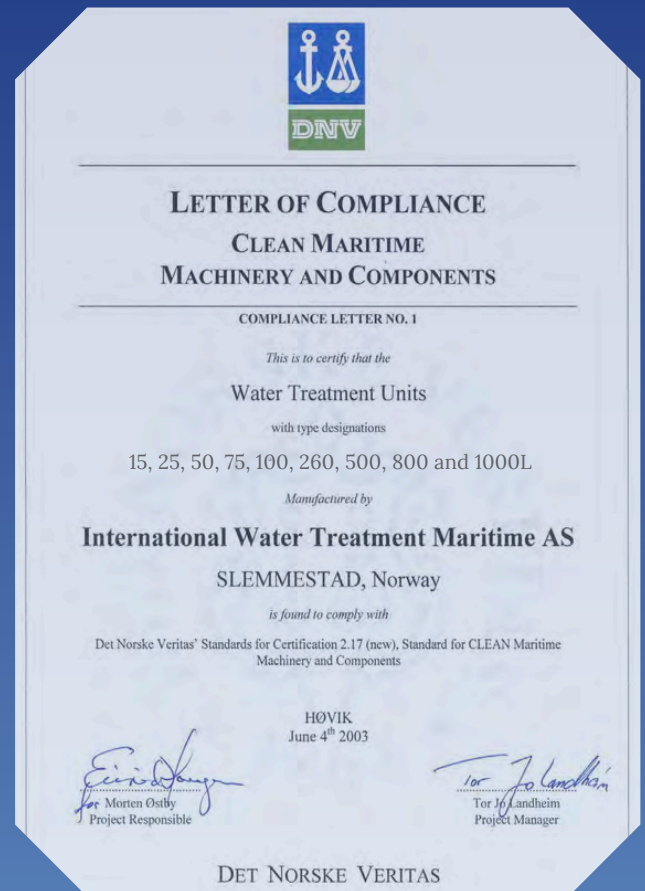

SUTTON BUSINESS CENTRE
RESTMOR WAY
WALLINGTON SM6 7AH

WWW.IWTM-UK.COM
T: +44 208 255 2903
E: INFO@IWTM-UK.COM

PROTECTOR P40 MANUAL



WWW.IWTM-UK.COM
T: +44 208 255 2903
E: INFO@IWTM-UK.COM

TABLE OF CONTENTS

03	DESCRIPTION & FEATURES
05	INSTALLATION
08	DATA & MEASUREMENTS
10	MAINTENANCE
16	ACCESSORIES
17	VALVE KIT
18	SERVICE JOURNAL

DESCRIPTION & FEATURES

WHAT IS PROTECTOR P40?

Protector P40 is a model from our IWTM Protector™ range, a unique side stream filtration device that engineers the system water to a non-corrosive state.

It provides corrosion protection in both new and existing heating and cooling systems, by removing sludge, particles, oxygen and other corrosive products. Therefore the system is maintained in the best possible way, by constantly filtering and engineering the water using electrochemistry and anode technology. The result is that its cleaning and engineering the water at the same time.

NEXT GENERATION OF ELECTROCHEMISTRY

The units provide faster clean-up of old systems and quicker compliance with pre commissioning targets on new systems due to the higher flow rates through the reaction tank (cathode) and the inbuilt ss micron filter that enables finer filtration. The unscreened larger anodes last longer and release the magnesium hydroxide quicker for faster pH control. Compliance with VDI 2035 is still obtained as the anodes sit inside the ss micron filter to capture the magnesium residue when the anodes expire.

- Protector is an "all in one solution"
- Controls the three key parameters of VDI 2035 ; pH, conductivity & dissolved oxygen.
- Creates a hostile environment for bacteria
- Keeps the water clean in closed circulation systems and removes all particles and impurities

Protector P40 is completely insulated and clad to prevent heat loss and condensation. In closed systems typical installation will be in side stream but, it can also be installed in the main flow in a modular arrangement for larger systems. This provides a method of easy installation, operation and maintenance.

PARTICLE FILTRATION

Protector P40 comes as standard with a robust stainless steel micron filter, which is 40 micron nominal. The stainless steel AISI 316, 40µm filter, has a large surface which gives a long operating time before cleaning and thus less flushing and refilling.

Optional bag filters are also available, with a filter degree down to 1 µm.

Please note: The 40 micron stainless steel filter supplied with the Protector as standard although robust in its manufacturing is a consumable item.

It's life expectancy is dependent on the harsh environment it has to deal with when being used to clean existing systems and therefore is not covered by any warranty. On a new system it is possible that the filter can last for many years, but on clean-up project it may only last for a few months.



Bag Filter

2-Layer S.S Filter

DESCRIPTION & FEATURES

NEODYMIUM MAGNETS

One long, dry, powerful magnet is mounted in the centre of the ss micron filter and in front of the sacrificial anodes so that magnetite is captured and not deposited on the anodes, also preventing the ss micron filter from clogging up with magnetite. This provides longer service intervals as well as increased operational life and better function. When the magnet is lifted out, all magnetite will be released and can be drained out.



SACRIFICIAL ANODES

Magnesium anodes that provide anodic water treatment and lower the fluid's conductivity.

The anodes also scavenge oxygen and regulate the pH level.

For longer life expectancy, the anodes are encapsulated by a stainless steel ss micron filter, removing the need for individual anode screens.

INSTALLATION



For larger volume systems, installation in series is possible.

SIDE STREAM INSTALLATION USING EXISTING PUMP

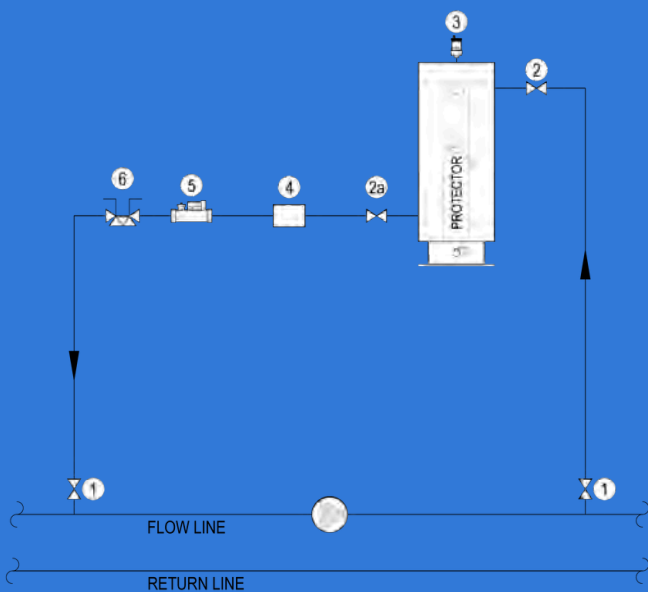

KEY

- 1. CLIENT IV'S NOT SUPPLIED
- 2. DRAIN COCK LEVER IV MALE & FEMALE
- 2a. LEVER IV MALE & FEMALE
- 3. 551 CALEFFI UNIT AIR VENT
- 4. MECHANICAL WATER METER
- 5. PICV
- 6. FLUSHING BY-PASS FOR RESIN RINSING

Protector P40 to be mounted in a “bypass” installation over an existing circulation pump. (Separate circulation pump can be used if needed.)

-Pressure side on pump should be to the inlet on Protector P40 unit.

-Suction side on pump should be to the outlet on Protector P40 unit.

INSTALLING CONNECTIONS

- 2 pc 1” Female Connections (inlet / outlet)
- 2 pc 1” Plugs (for connections not in use.)
- 2 pc 1” Ball Valves
- 2 pc 1” Plugs
- 1 pc 1” Flowmeter
- 1 pc 1” PICV
- 1 pc 1/2” Air Vent
- 1 pc 1” Drain Valve
- 1 Test Point Valve



Ensure that 1000mm clearance is left above the Protector AAV.

Ensure that 600mm clearance is left in front.

INSTALLATION

SIDE STREAM INSTALLATION USING OWN PUMP

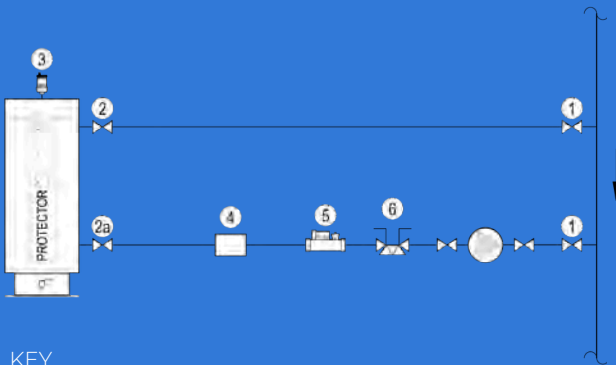

KEY

- 1. CLIENT IV's NOT SUPPLIED
- 2. DRAIN COCK LEVER IV MALE & FEMALE
- 2a. LEVER IV MALE & FEMALE
- 3. 551 CALEFFI UNIT AIR VENT
- 4. MECHANICAL WATER METER
- 5. PICV
- 6. FLUSHING BY-PASS FOR RESIN RINSING



CONNECTIONS

Can be connected:

- IN from either left or right. (only on the top)
- OUT from left or right. (only on the bottom)

-Connections not in use, to be plugged. (1" female threads)



INSTALLATION

INSTALLATION & COMMISSIONING INSTRUCTIONS - PETTINAROLI VALVE

- Close the outlet valve.
- Keeping outlet closed whilst opening the inlet valve.
- Open the automatic air vent.
- Fill the Protector unit once the automatic air vent has dispensed all of the air.
- Open the outlet valve so water flows through the Protector.
- Check the water meter is rotating.
- Set PIC valve as below:



- Remove the handwheel. default setting: position 9

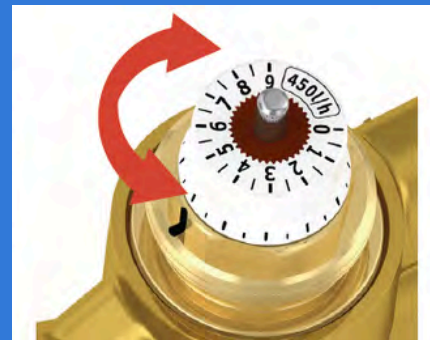

- Turn the selector to the target position to set the flow rate, the settings should be:

Setting 6.5 for 40l/min for the P40

Once you have set this up check the flow rate on the water meter corresponds to required settings on the PICV:

by reading the 0.01 cubic meter dial (=10 litres) , which corresponds to litres per minute.

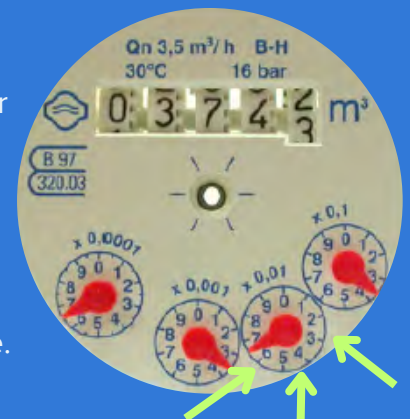

For example it should take 1 minute for the red arrow to read 4 if the setting on the PICV is 6.5 for 40 litres a minute.



- Re-assemble the hand wheel cap with a 3/4" turn to protect the spindle – do not turn more than this or you will push the spindle down and effect the flow rate.

DATA & MEASUREMENTS

PROTECTOR P40 DATA

System Volume: Heating -Max. 40m³

Cooling - Max. 30m³

Flow: Heating - 30m³ - 30l/min

- 40m³ - 40l/min

Cooling - 20m³ - 30l/min

- 30m³ - 40l/min

Empty Weight: 59KG

Full Weight: 116KG

Shipping Weight: 69KG

Design Pressure – PN10

Max Temperature - 95°C

Volume of Unit - 57L

Design Code – PED 2014/68/EU

Connection - 1" female thread / BSPP

MATERIALS

Filter House: Stainless steel AISI 304

SS Micron Filter: Stainless steel AISI 316L

Gasket: EPDM

Insulation/Mantling: Armaflex /stainless steel

Anodes: Magnesium

Magnet: Neodymium

Surface Treatment: Brushed Stainless Steel

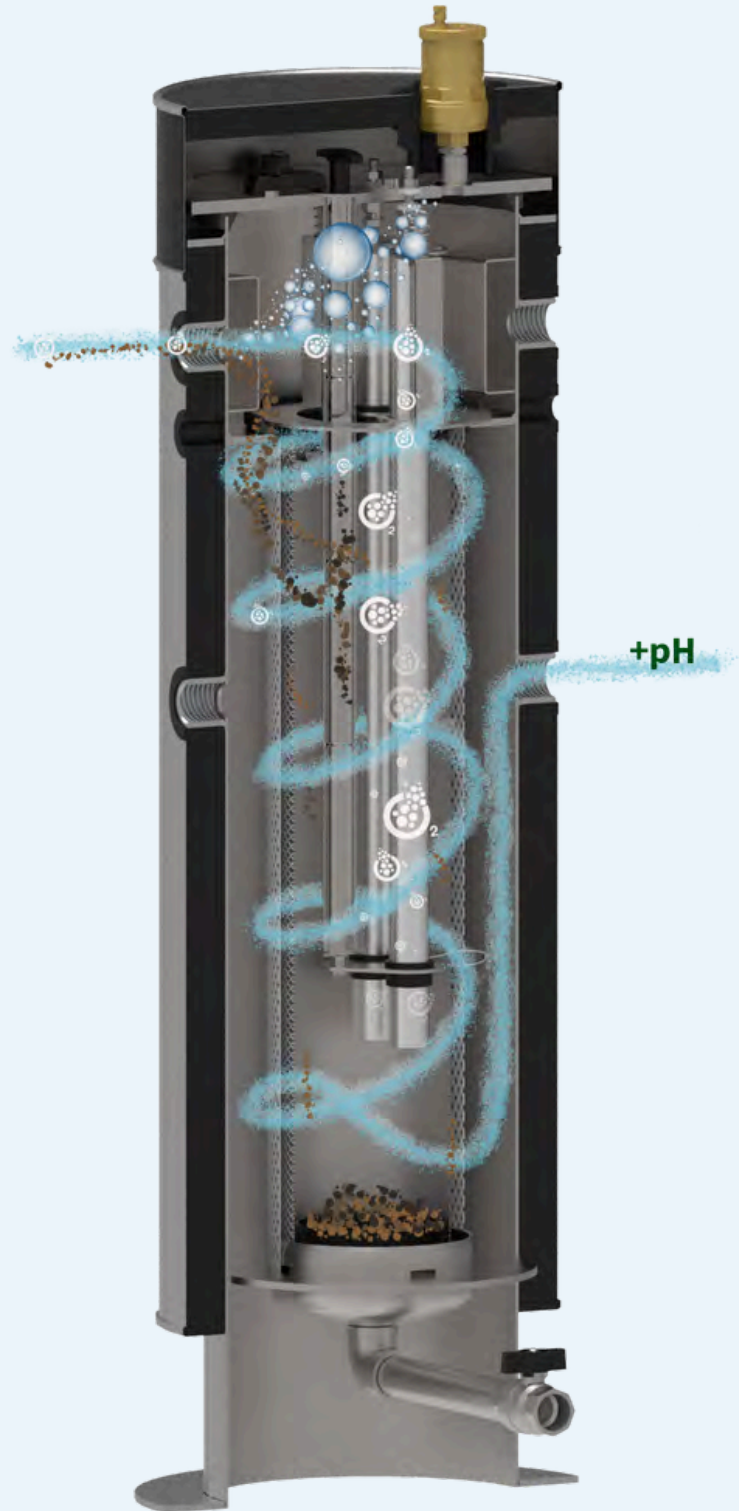

Note: Talk to us for systems that operate at higher pressures or higher temperatures.

DATA & MEASUREMENTS

PROTECTOR P40 MEASUREMENTS

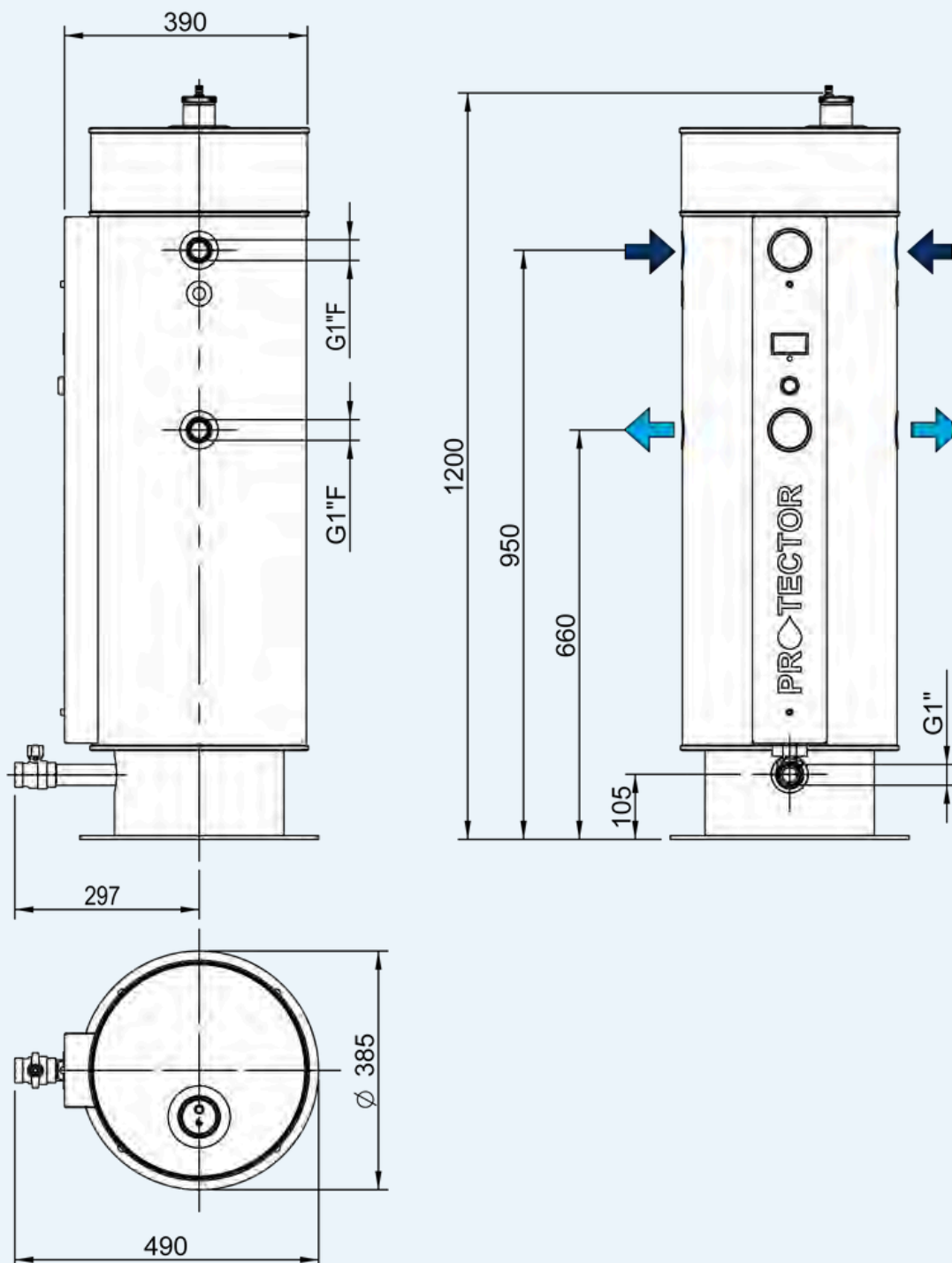

MAINTENANCE

DRAINING

The Protector P40 unit needs to be drained frequently ; how often is dependent on the water quality.

The higher the starting conductivity level, the more sludge there will be, resulting in a need for more frequent draining.

This is to flush out the sludge and particles that have been collected in the bottom of the tank, from the magnet trap and the ss micron filter.

The one piece long magnet in the Protector P40 is inserted on top of the tank on the flange lid.

- Close the inlet to the Protector P40.
- Pull out the magnet on top of tank.
- Open the drain valve in the bottom of tank and flush until the water is running clear of debris.
- When complete, close the drain valve and put the magnet back in the sleeve.

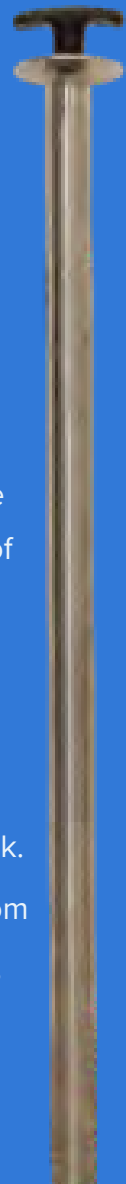

MAINTENANCE

ANALOGUE GALVANOMETER & PUSH BUTTON

The analogue galvanometer shows the galvanic current in milliamps between the anodes and the cathode (the tank body), with the system water being the medium.

The analogue galvanometer is always in a continuous reading position ; when the switch is pressed, the instrument is short circuited and shows little or no reading. This function is only for testing the analogue meter itself.

Pure water is non conducting, therefore the more impurities and oxygen in the water the more current will flow between the anode and the cathode.

When the water quality improves, the current diminishes and may measure even as low as 0.2 to 0.3 milliamps when the system water is fully passive.

The Protector P40 system is self-regulating, the anode automatically works harder with corrosive water than with water that is no longer reactive.



The needle swing lies between 10% and 100%.

This is the normal operating region. The lower the reading, the less the anode needs to work, and the less impurities are in the system water.

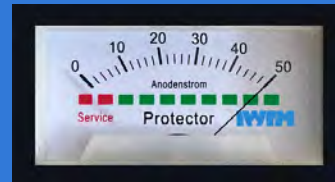

The needle always reads 100%.

The anode is working hard.

If the needle remains in this position for longer than one heating season, the Protector P40 may be undersized for the system.

Action: check the system volume

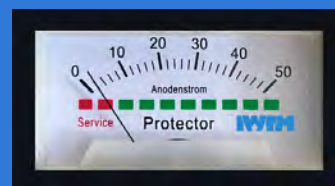

The needle lies continuously close to the red region ;

the needle still drops

to the minimum reading when you press the test button however, the anode no longer needs to work because the chemical reactions in the water have finished, the anode can no longer work because it is coated in a barrier layer, or or the anode may be close to expiring and needs replacing.

MAINTENANCE

ANALOGUE GALVANOMETER & PUSH BUTTON

Action: remove the sludge from the Protector P40 and fill with fresh water. Keep the isolation valves closed for a day to hold the more corrosive fresh water inside the Protector P40.

After a day, if the operating meter shows a higher reading, everything is operating correctly, and the Protector P40 can be put back into operation. Otherwise, you need to open the lid to inspect the appliance.

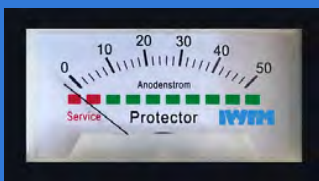

The needle drops into the red region within a few weeks.

The anode is spent or coated in a barrier layer or the Protector P40 is isolated from the system and no water is circulating through it.

Action: check circulation or open the appliance and clean or replace the anodes.

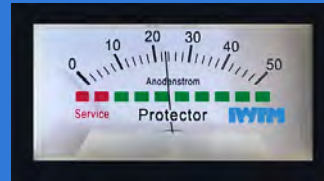

The meter continues to show a constant reading over a long period.

The operating meter might be faulty.

Action: press the test button to check the meter (the needle should drop to the left).

If there is no change in the needle position, the meter is probably faulty.

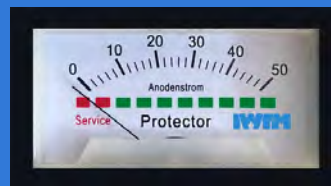

After servicing, if the indicator position is hard left in the red.

If the anode wires are connected wrong, it will create a short circuit and the swing meter will sit in the red zone and will raise up slightly when pressing the test button. Action: change the two connection wires around on the anode and the earth.

While the Protector P40 is increasing the pH and scavenging oxygen the water gets less aggressive and the current will decrease and stabilise. (normally from 4-15 mA). If some chlorides or sulphates should interfere, resulting in higher conductivity or increased oxygen (feed water), the ampere & output will increase again.

MAINTENANCE

MAGNESIUM ANODES

The filter anodes are in a basket of stainless steel wire mesh, called the ss micron filter and do not normally need any cleaning, if however, they are coated in slime from chemical residue or any other debris this can be removed with a suitable scraper to get back to the bare anode surface. Check the anodes for proper functioning (mA instrument).



TOOLS:

- Isolating nut dry side 13 mm spanner
- Isolating bolt wet side 17 mm spanner
- Anode bolt 10 mm spanner
- Flange cover nuts 19 mm spanner

SERVICE

Service on the Protector P40 unit should be done once a year. However, this is also depending upon the quality of the system water.

If there has been an existing problem with sludge, sediments etc. before the Protector installation, we recommend a first service after 3 months of operation. It's also important to take a water sample out of the system, for analysis in a laboratory.

The isolation screw going through the flange has two nylon washers one on each side of the flange. Once opened, they **cannot** be reused. These washers are not part of the replacement kit. So please do not undo the isolation screw.

Make sure not to rotate the bolt while changing the anode. Use a 17mm spanner to hold the isolation bolt securely whilst removing/fitting the anode bolt with a 10mm spanner. This will ensure the isolation screw does not turn. Once the anode has been replaced, use a test meter to check there is no continuity between the anode & the flange. The two isolation washers have two functions 1. To create a watertight seal 2. To electrically isolate the anode from the tank.

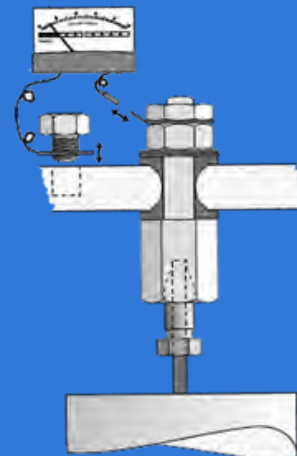

MAINTENANCE

SERVICE

- Close the inlet and outlet ball valves.
- Unscrew the air vent and empty the tank through the drain valve.
- Unscrew the flange lid.
- Carefully lift up the lid, the anodes are attached to the underside.
- Check the anodes and the magnesium rods.
- Flush the anodes, if the magnesium is below 10mm diameter, replace with new ones.
- Take out the ss micron filter and flush / clean.
- Clean the tank inside using a hose or a pressure gun.
- Check all parts belonging to the Protector and clean them if required. (AAV, flowmeter, PICV etc.)

When replacing the anode hold the isolation screw going through the flange and unscrew only the small inner screw at the end of the steel core of the anode. After mounting a new anode, make sure that all screws are tight and that the electrical wiring is properly reinstalled. If there's no indication on the meter, the Protector P40 is not working, so please check the wiring is correct.

When done, put everything back in place and fill up the Protector P40 on the inlet. When the air vent stops letting out air, the tank is refilled and you can open the outlet and start the circulation again.

Check that the flowmeter is running.

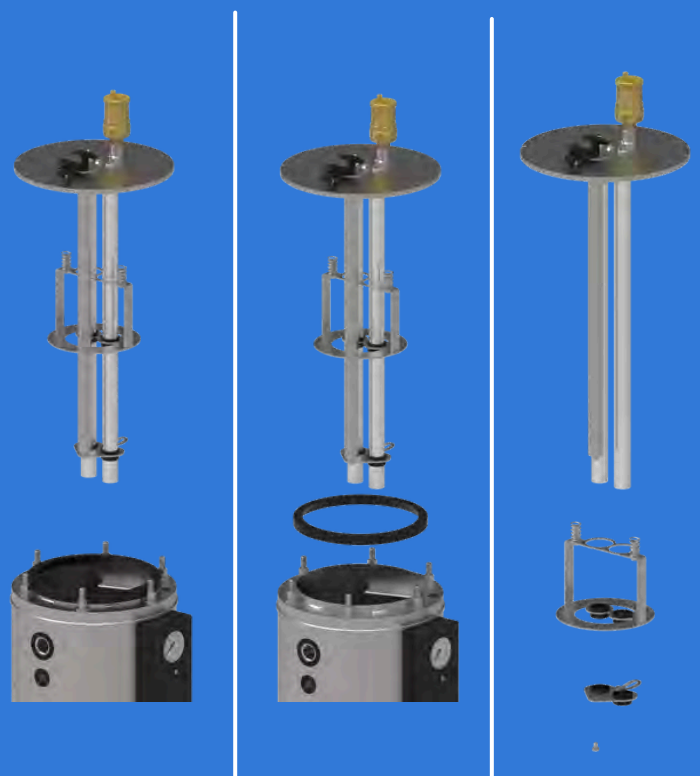
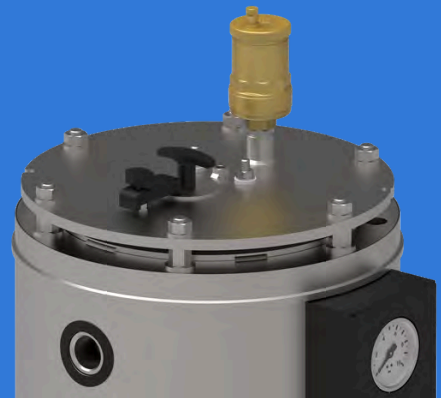

MAINTENANCE

PARTICLE FILTER

Inside the Protector P40 unit is installed a ss micron filter, to catch and remove all sediments and particles.

- The ss micron filter is locked with a small metal clip in the bottom.
- Just twist the ss micron filter slightly to the top left and lift it out.
- Clean the ss micron filter with a water hose.
- Make sure all particles are removed from the ss micron filter.

When done just put it back, turn it slightly to the right and its locked again.



(AISI 316 with
110µm or 55µm
filter element.)



ACCESSORIES

Part No.	Description
Protector – Complete Units	
FZPRBGO34	PROTECTOR P40 ANALOG 1" F WITH UK VALVE KIT
Protector – Filtering Elements	
CABAGO001	FELT BAG PES SIZE O2 Ø 178 x L 813 mm 1µm
CABAGO002	FELT BAG PES SIZE O2 Ø 178 x L 813 mm 5µm
CABAGO003	FELT BAG PES SIZE O2 Ø 178 x L 813 mm 10µm
CABAGO004	FELT BAG PES SIZE O2 Ø 178 x L 813 mm 25µm
Protector – Stainless Steel Strainers	
AMCRT0104	2 LAYER INOX SS MICRON FILTER SIZE 11, 40MM
Protector – Spare Parts	
CDGRN0005	HOUSING GASKET Ø273 (EPDM)
CDGRN0020	BAG HOLDER GASKET (EPDM)
101563	ANODE SET NO MESH – PROTECTOR P40
CASCM0015	AIR VENT
100078	ANALOG INDICATOR

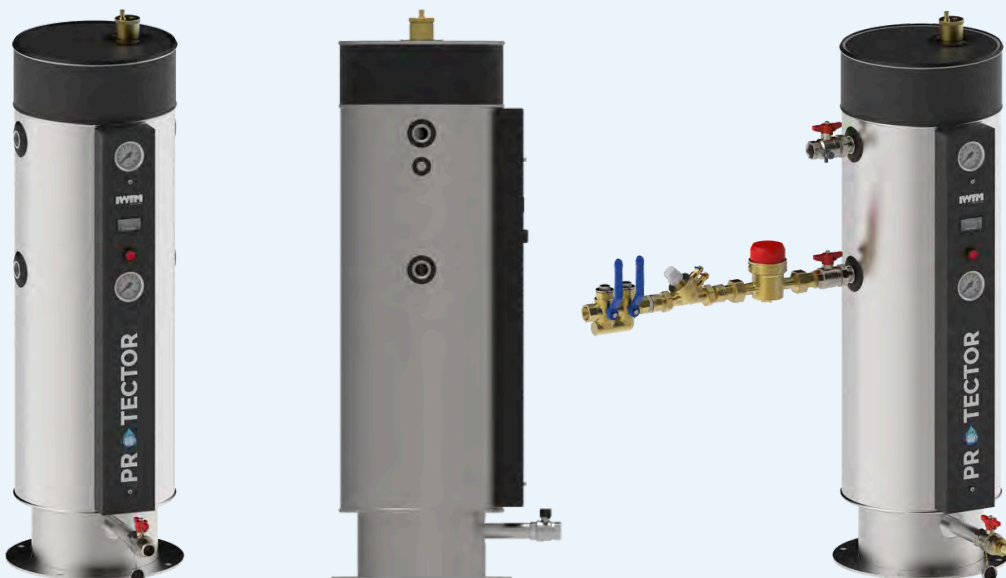

VALVE KIT

The Protector P40 is supplied with the following valve kit which is packed inside the main Protector P40 box.



Environmental Culture Change

be a part of it

clean | protect | prevent





Founded in 1992, IWTM have been working with chemical free water treatment using electrochemistry for over 30 years and have offices in Norway, UK, Finland, Sweden, Canada, USA and a worldwide presence in the Marine sector.

We have developed models specifically suited to the higher demands of the marine industry operating at higher pressures and higher temperatures. The marine products are provided worldwide on the world's largest cruise ships working with the leading operators in this sector.

Having secured DNV approval in 2003, we are still the only chemical free water treatment manufacturer to have this certification and approval. DNV is a globally leading quality assurance and risk management company operating in more than 100 countries.

The IWTM Protector™ is our most recently developed product. The Protector range is now available to our land-based customers.

Version 8: July 2024

In line with continued product development we reserve the right to make any changes to this document without any given notice.

PROTECTOR



SUTTON BUSINESS CENTRE
RESTMOR WAY
WALLINGTON SM6 7AH

WWW.IWTM-UK.COM
T: +44 208 255 2903
E: INFO@IWTM-UK.COM

PROTECTOR P25 MANUAL



WWW.IWTM-UK.COM
T: +44 208 255 2903
E: INFO@IWTM-UK.COM

TABLE OF CONTENTS

03	DESCRIPTION & FEATURES
05	INSTALLATION
08	DATA & MEASUREMENTS
10	MAINTENANCE
16	ACCESSORIES
17	VALVE KIT
18	SERVICE JOURNAL

DESCRIPTION & FEATURES

WHAT IS PROTECTOR P25?

Protector P25 is a model from our IWTM Protector™ range, a unique side stream filtration device that engineers the system water to a non-corrosive state.

It provides corrosion protection in both new and existing heating and cooling systems, by removing sludge, particles, oxygen and other corrosive products. Therefore the system is maintained in the best possible way, by constantly filtering and engineering the water using electrochemistry and anode technology. The result is that its cleaning and engineering the water at the same time.

NEXT GENERATION OF ELECTROCHEMISTRY

The units provide faster clean-up of old systems and quicker compliance with pre commissioning targets on new systems due to the higher flow rates through the reaction tank (cathode) and the inbuilt ss micron filter that enables finer filtration. The unscreened larger anodes last longer and release the magnesium hydroxide quicker for faster pH control. Compliance with VDI 2035 is still obtained as the anodes sit inside the basket to capture the magnesium residue when the anodes expire.



Bag Filter

2-Layer S.S Filter

- Protector is an "all in one solution"
- Controls the three key parameters of VDI 2035 ; pH, conductivity & dissolved oxygen.
- Creates a hostile environment for bacteria
- Keeps the water clean in closed circulation systems and removes all particles and impurities

Protector P25 is completely insulated and clad to prevent heat loss and condensation.

In closed systems typical installation will be in side stream but, it can also be installed in the main flow in a modular arrangement for larger systems. This provides a method of easy installation, operation and maintenance.

PARTICLE FILTRATION

Protector P25 comes as standard with a robust ss micron filter, which is 40 micron nominal. The stainless steel AISI 316, 40µm filter, has a large surface which gives a long operating time before cleaning and thus less flushing and refilling.

Optional bag filters are also available, with a filter degree down to 1 µm.

Please note: The 40 micron stainless steel filter supplied with the Protector as standard although robust in its manufacturing is a consumable item.

It's life expectancy is dependent on the harsh environment it has to deal with when being used to clean existing systems and therefore is not covered by any warranty. On a new system it is possible that the filter can last for many years, but on clean-up project it may only last for a few months.

DESCRIPTION & FEATURES

NEODYMIUM MAGNETS

The Protector P25 comes with two, double piece, short dry, powerful magnets. These are mounted in the centre of the ss micron filter and in front of the sacrificial anodes so that magnetite is captured and not deposited on the anodes, also preventing the ss micron filter basket from clogging up with magnetite. This provides longer service intervals as well as increased operational life and better function. When the magnets are lifted out, all magnetite will be released and can be drained out.

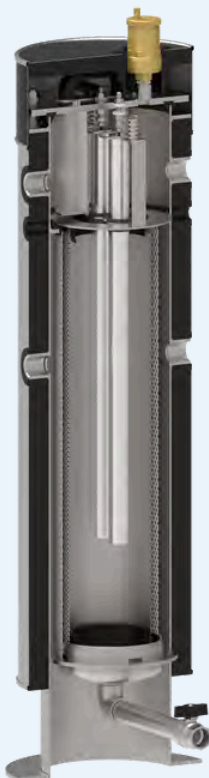

SACRIFICIAL ANODES

Magnesium anodes that provide anodic water treatment and lower the fluid's conductivity.

The anodes also scavenge oxygen and regulate the pH level.

For longer life expectancy, the anodes are encapsulated by a stainless steel ss micron filter, removing the need for individual anode screens.

INSTALLATION

SIDE STREAM INSTALLATION USING EXISTING PUMP

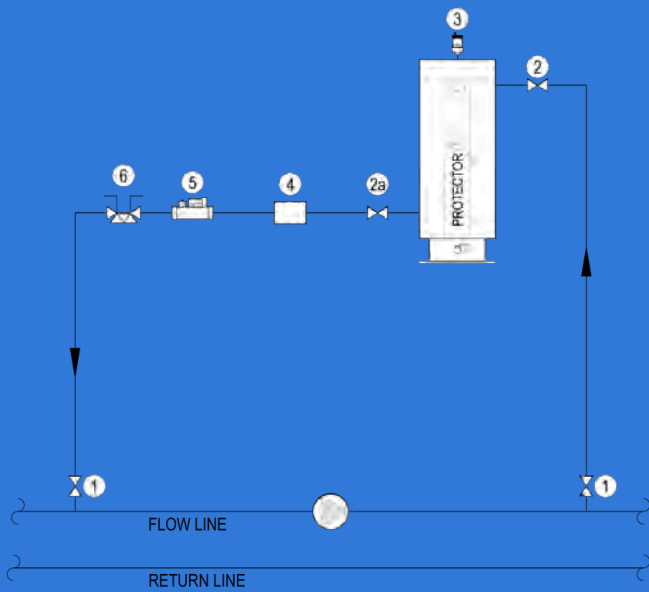

KEY

1. CLIENT IV's NOT SUPPLIED
2. DRAIN COCK LEVER IV MALE & FEMALE
- 2a. LEVER IV MALE & FEMALE
3. 551 CALEFFI UNIT AIR VENT
4. MECHANICAL WATER METER
5. PICV
6. FLUSHING BY-PASS FOR RESIN RINSING

Protector P25 to be mounted in a “bypass” installation over an existing circulation pump. (Separate circulation pump can be used if needed.)

-Pressure side on pump should be to the inlet on Protector P25 unit.

-Suction side on pump should be to the outlet on Protector P25 unit.

INSTALLING CONNECTIONS

- 2 pc 1” Female Connections (inlet / outlet)
- 2 pc 1” Plugs (for connections not in use.)
- 2 pc 1” Ball Valves
- 2 pc 1” Plugs
- 1 pc 1” Flowmeter
- 1 pc 1” PICV
- 1 pc 1/2” Air Vent
- 1 pc 1” Drain Valve
- 1 Test Point Valve



Ensure that 1000mm clearance is left above the Protector AAV.

Ensure that 600mm clearance is left in front.

INSTALLATION

SIDE STREAM INSTALLATION USING OWN PUMP

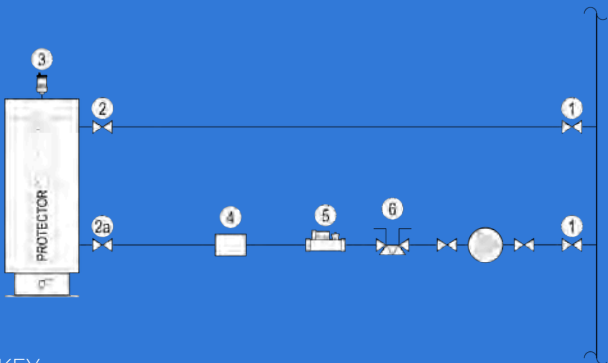

KEY

- 1. CLIENT IV's NOT SUPPLIED
- 2. DRAIN COCK LEVER IV MALE & FEMALE
- 2a. LEVER IV MALE & FEMALE
- 3. 551 CALEFFI UNIT AIR VENT
- 4. MECHANICAL WATER METER
- 5. PICV
- 6. FLUSHING BY-PASS FOR RESIN RINSING



↑
**COVER MUST BE ROTATED
ACCORDINGLY
TO FLOW DIRECTION**



CONNECTIONS

Can be connected:

- IN from either left or right. (only on the top)
- OUT from left or right. (only on the bottom)
- Connections not in use, to be plugged. (1" female threads)

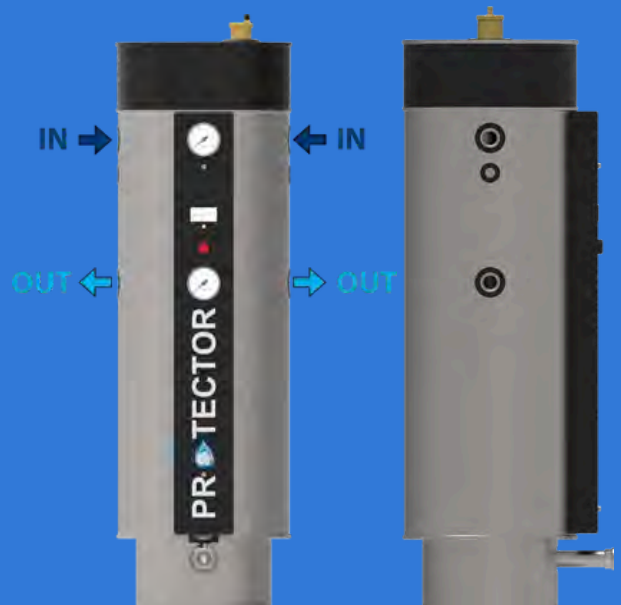

INSTALLATION

INSTALLATION & COMMISSIONING INSTRUCTIONS - PETTINAROLI VALVE

- Close the outlet valve.
- Keeping outlet closed whilst opening the inlet valve.
- Open the automatic air vent.
- Fill the Protector unit once the automatic air vent has dispensed all of the air.
- Open the outlet valve so water flows through the Protector.
- Check the water meter is rotating.
- Set PIC valve as below:

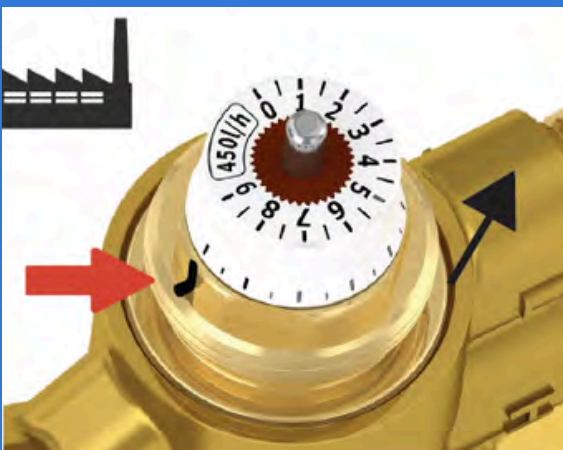

- Remove the handwheel. default setting: position 9



- Turn the selector to the target position to set the flow rate, the settings should be:

Setting 4.5 for 25l/min for the P25

Once you have set this up check the flow rate on the water meter corresponds to required settings on the PICV:

by reading the 0.01 cubic meter dial (=10 litres) , which corresponds to litres per minute.

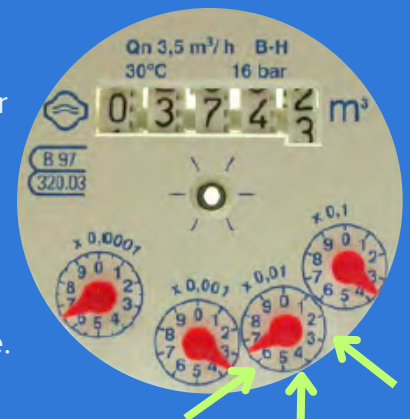

For example it should take 1 minute for the red arrow to read 2.5 if the setting on the PICV is 4.5 for 25 litres a minute.



- Re-assemble the hand wheel cap with a 3/4" turn to protect the spindle – do not turn more than this or you will push the spindle down and effect the flow rate.

DATA & MEASUREMENTS

PROTECTOR P25 DATA

System Volume: Heating -Max. 25m³

Cooling - Max. 17.5m³

Flow: Heating - 15m³ - 20l/min

- 25m³ - 25l/min

Cooling - 10m³ - 20l/min

- 17.5m³ - 25l/min

Empty Weight: 50KG

Full Weight: 81KG

Shipping Weight: 60KG

Design Pressure – PN10

Max Temperature - 95°C

Volume of Unit - 31L

Design Code – PED 2014/68/EU

Connection - 1" female thread / BSPP

MATERIALS

Filter House: Stainless steel AISI 304

SS Micron Filter: Stainless steel AISI 316L

Gasket: EPDM

Insulation/Mantling: Armaflex /stainless steel

Anodes: Magnesium

Magnet: Neodymium

Surface Treatment: Brushed Stainless Steel

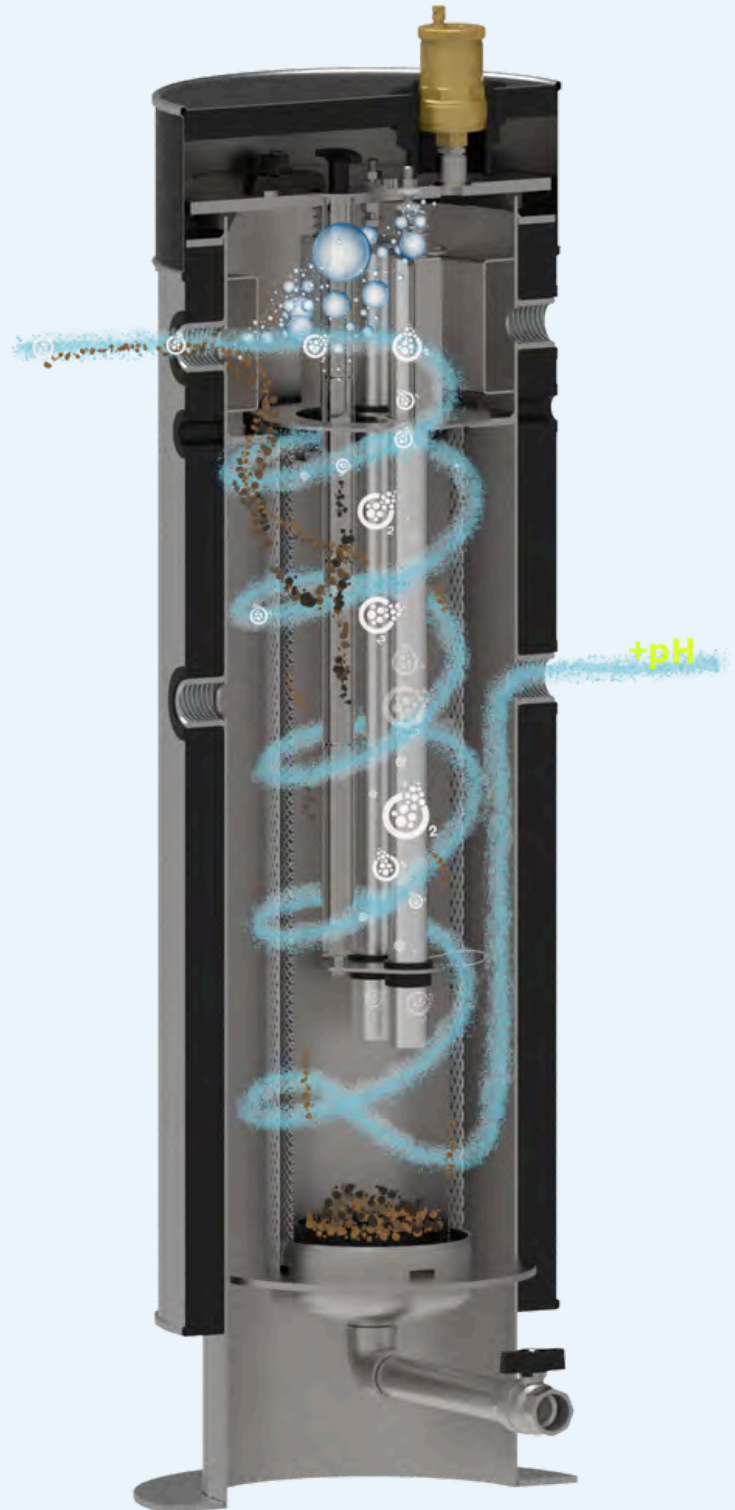

Note: Talk to us for systems that operate at higher pressures or higher temperatures.

DATA & MEASUREMENTS

PROTECTOR P25 MEASUREMENTS

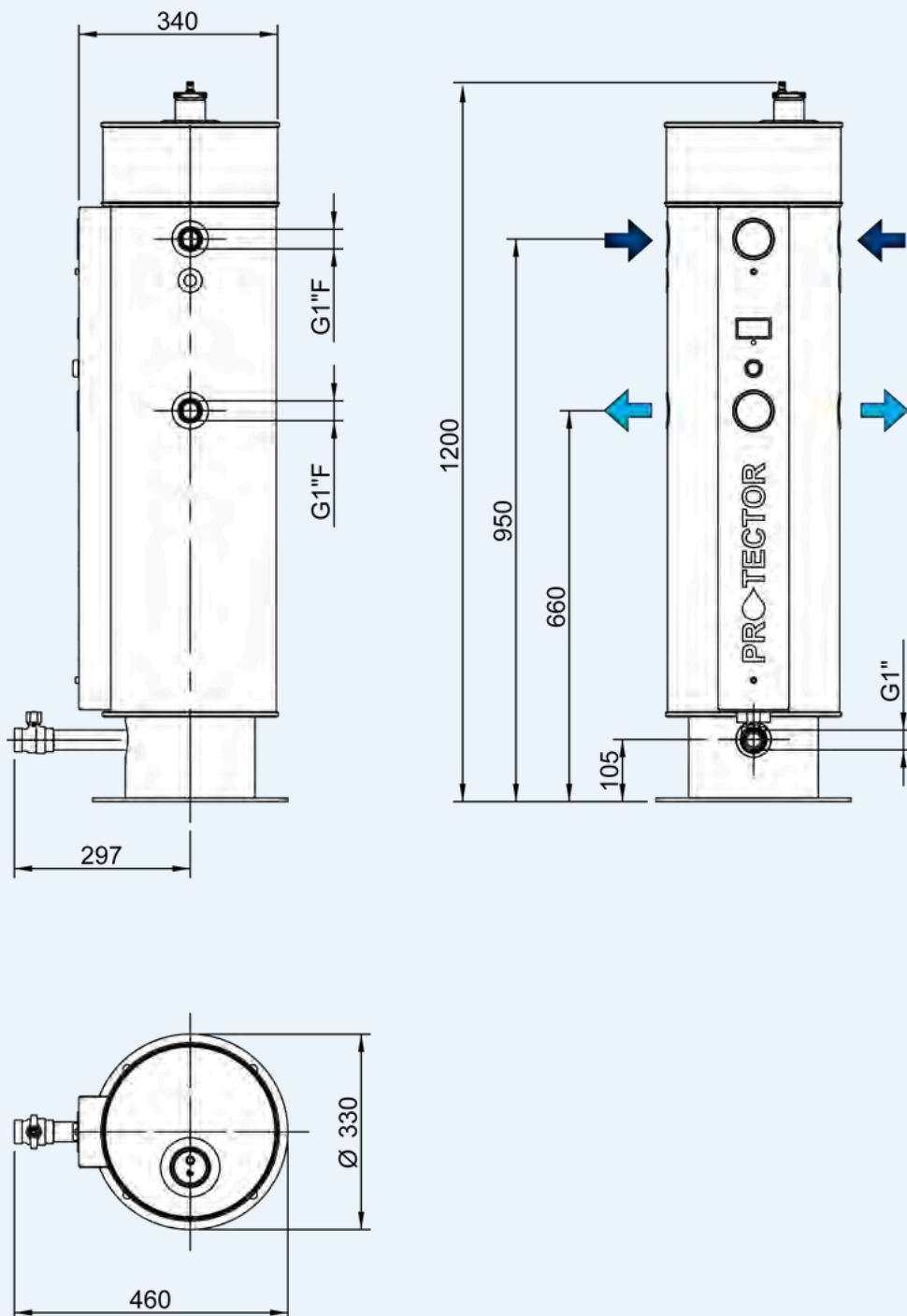

MAINTENANCE

DRAINING

The Protector P25 unit needs to be drained frequently ; how often is dependent on the water quality.

The higher the starting conductivity level, the more sludge there will be, resulting in a need for more frequent draining.

This is to flush out the sludge and particles that have been collected in the bottom of the tank, from the magnet trap and the ss micron filter .

The magnet in the Protector P25 comes as 2 pieces, shorter double magnets. The magnets are inserted on top of the tank, on the flange lid.

- Close the inlet to the Protector
- Pull out the magnets on top of tank.
- Open the drain valve in the bottom of tank and flush until the water is running clear of debris.
- When complete, close the drain valve and put the magnet back in the sleeve.



MAINTENANCE

ANALOGUE GALVANOMETER & PUSH BUTTON

The analogue galvanometer shows the galvanic current in milliamps between the anodes and the cathode (the tank body), with the system water being the medium.

The analogue galvanometer is always in a continuous reading position ; when the switch is pressed, the instrument is short circuited and shows little or no reading. This function is only for testing the analogue meter itself.

Pure water is non conducting, therefore the more impurities and oxygen in the water the more current will flow between the anode and the cathode.

When the water quality improves, the current diminishes and may measure even as low as 0.2 to 0.3 milliamps when the system water is fully passive.

The Protector P25 system is self-regulating, the anode automatically works harder with corrosive water than with water that is no longer reactive.



The needle swing lies between 10% and 100%.

This is the normal operating region. The lower the reading, the less the anode needs to work, and the less impurities are in the system water.

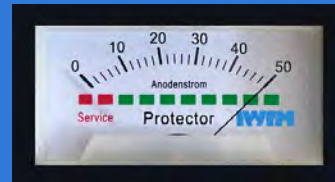

The needle always reads 100%.

The anode is working hard.

If the needle remains in this position for longer than one heating season, the Protector P25 may be undersized for the system.

Action: check the system volume

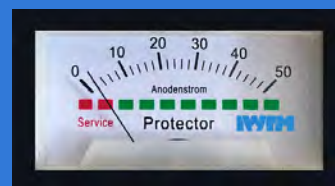

The needle lies continuously close to the red region ;

the needle still drops

to the minimum reading when you press the test button however, the anode no longer needs to work because the chemical reactions in the water have finished, the anode can no longer work because it is coated in a barrier layer or the anode may be close to expiring and needs replacing.

MAINTENANCE

ANALOGUE GALVANOMETER & PUSH BUTTON

Action: remove the sludge from the Protector P25 and fill with fresh water. Keep the isolation valves closed for a day to hold the more corrosive fresh water inside the Protector P25.

After a day, if the operating meter shows a higher reading, everything is operating correctly, and the Protector P25 can be put back into operation. Otherwise, you need to open the lid to inspect the appliance.

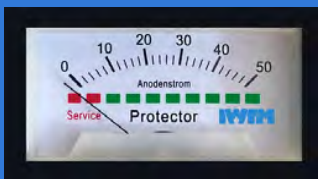

The needle drops into the red region within a few weeks.

The anode is spent or coated in a barrier layer or the Protector P25 is isolated from the system and no water is circulating through it.

Action: check circulation or open the appliance and clean or replace the anodes.

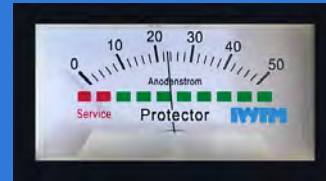

The meter continues to show a constant reading over a long period.

The operating meter might be faulty.

Action: press the test button to check the meter (the needle should drop to the left).

If there is no change in the needle position, the meter is probably faulty.

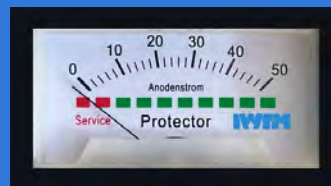

After servicing, if the indicator position is hard left in the red.

If the anode wires are connected wrong, it will create a short circuit and the swing meter will sit in the red zone and will raise up slightly when pressing the test button. Action: change the two connection wires around on the anode and the earth.

While the Protector P25 is increasing the pH and scavenging oxygen the water gets less aggressive and the current will decrease and stabilise. (normally from 4-15 mA). If some chlorides or sulphates should interfere, resulting in higher conductivity or increased oxygen (feed water), the ampere & output will increase again.

MAINTENANCE

MAGNESIUM ANODES

The filter anodes are in a basket of stainless steel wire mesh, called the ss micron filter and do not normally need any cleaning, if however, they are coated in slime from chemical residue or any other debris this can be removed with a suitable scraper to get back to the bare anode surface.

Check the anodes for proper functioning (mA instrument).



TOOLS:

- Isolating nut dry side 13 mm spanner
- Isolating bolt wet side 17 mm spanner
- Anode bolt 10 mm spanner
- Flange cover nuts 19 mm spanner

SERVICE

Service on the Protector P25 unit should be done once a year. However, this is also depending upon the quality of the system water.

If there has been an existing problem with sludge, sediments etc. before the Protector installation, we recommend a first service after 3 months of operation. It's also important to take a water sample out of the system, for analysis in a laboratory.

The isolation screw going through the flange has two nylon washers one on each side of the flange. Once opened, they **cannot** be reused. These washers are not part of the replacement kit. So please do not undo the isolation screw.

Make sure not to rotate the bolt while changing the anode. Use a 17mm spanner to hold the isolation bolt securely whilst removing/fitting the anode bolt with a 10mm spanner. This will ensure the isolation screw does not turn. Once the anode has been replaced, use a test meter to check there is no continuity between the anode & the flange. The two isolation washers have two functions 1. To create a watertight seal 2. To electrically isolate the anode from the tank.

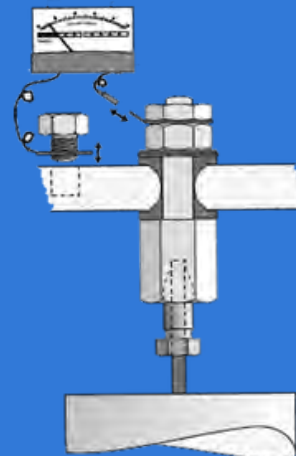

MAINTENANCE

SERVICE

- Close the inlet and outlet ball valves.
- Unscrew the air vent and empty the tank through the drain valve.
- Unscrew the flange lid.
- Carefully lift up the lid, the anodes are attached to the underside.
- Check the anodes and the magnesium rods.
- Flush the anodes, if the magnesium is below 10mm diameter, replace with new ones.
- Take out the ss micron filter and flush / clean.
- Clean the tank inside using a hose or a pressure gun.
- Check all parts belonging to the Protector and clean them if required. (AAV, flowmeter, PICV etc.)

When replacing the anode hold the isolation screw going through the flange and unscrew only the small inner screw at the end of the steel core of the anode. After mounting a new anode, make sure that all screws are tight and that the electrical wiring is properly reinstalled. If there's no indication on the meter, the Protector P25 is not working, so please check the wiring is correct.

When done, put everything back in place and fill up the Protector P25 on the inlet. When the air vent stops letting out air, the tank is refilled and you can open the outlet and start the circulation again. Check that the flowmeter is running.

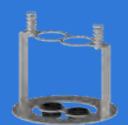

MAINTENANCE

PARTICLE FILTER

Inside the Protector P25 unit is installed a ss micron filter, to catch and remove all sediments and particles.

- The ss micron filter is locked with a small metal clip in the bottom.
- Just twist the ss micron filter slightly to the top left and lift it out.
- Clean the ss micron filter with a water hose.
- Make sure all particles are removed from the ss micron filter .

When done just put it back, turn it slightly to the right and its locked again.

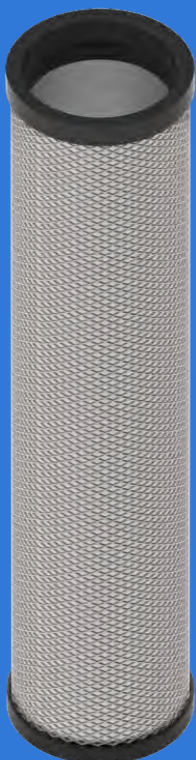

(AISI 316 with
40µm ss micron
filter .)



ACCESSORIES

Part No.	Description
Protector – Complete Units	
FZPRBG033	PROTECTOR P25 ANALOG 1" F WITH UK VALVE KIT
Protector – Filtering Elements	
CABAG0001	FELT BAG PES SIZE O2 Ø 178 x L 813 mm 1µm
CABAG0002	FELT BAG PES SIZE O2 Ø 178 x L 813 mm 5µm
CABAG0003	FELT BAG PES SIZE O2 Ø 178 x L 813 mm 10µm
CABAG0004	FELT BAG PES SIZE O2 Ø 178 x L 813 mm 25µm
Protector – Stainless Steel Strainers	
AMCRT0104	2 LAYER INOX SS MICRON FILTER SIZE 11, 40MM
Protector – Spare Parts	
CDGRN0004	HOUSING GASKET Ø219,1 (EPDM)
CDGRN0020	BAG HOLDER GASKET (EPDM)
101563	ANODE SET NO MESH – PROTECTOR P25
CASCM0015	AIR VENT
100078	ANALOG INDICATOR

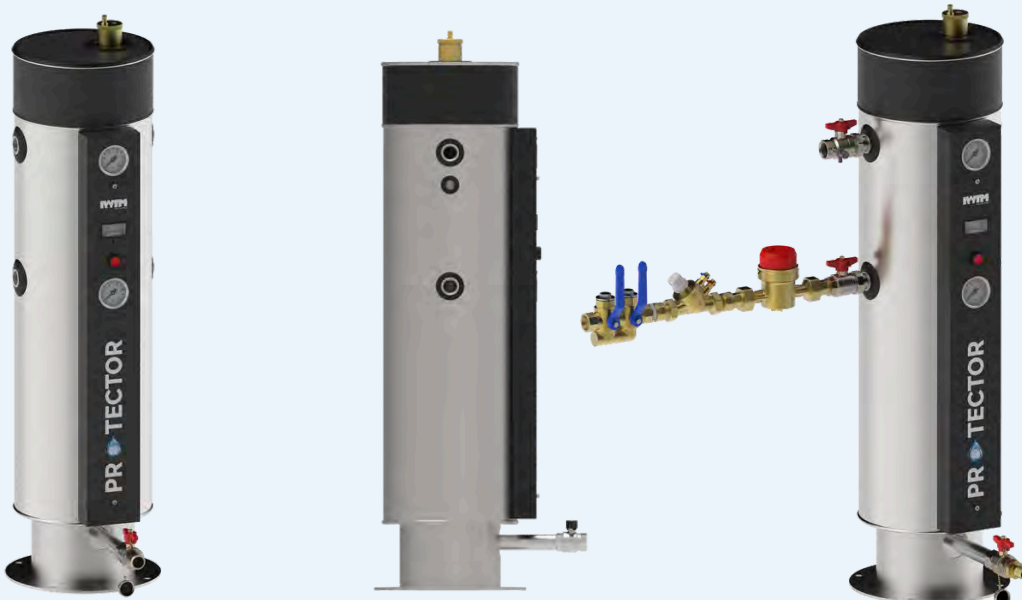

VALVE KIT

The Protector P25 is supplied with the following valve kit which is packed inside the main Protector P25 box.



Environmental Culture Change

be a part of it

clean | protect | prevent





Founded in 1992, IWTM have been working with chemical free water treatment using electrochemistry for over 30 years and have offices in Norway, UK, Finland, Sweden, Canada, USA and a worldwide presence in the Marine sector.

We have developed models specifically suited to the higher demands of the marine industry operating at higher pressures and higher temperatures. The marine products are provided worldwide on the world's largest cruise ships working with the leading operators in this sector.

Having secured DNV approval in 2003, we are still the only chemical free water treatment manufacturer to have this certification and approval. DNV is a globally leading quality assurance and risk management company operating in more than 100 countries.

The IWTM Protector™ is our most recently developed product. The Protector range is now available to our land-based customers.

Version 8: July 2024

In line with continued product development we reserve the right to make any changes to this document without any given notice.

PROTECTOR



SUTTON BUSINESS CENTRE
RESTMOR WAY
WALLINGTON SM6 7AH

WWW.IWTM-UK.COM
T: +44 208 255 2903
E: INFO@IWTM-UK.COM

PROTECTOR P10 MANUAL



WWW.IWTM-UK.COM
T: +44 208 255 2903
E: INFO@IWTM-UK.COM



TABLE OF CONTENTS

DESCRIPTION & FEATURES

INSTALLATION

DATA & MEASUREMENTS

MAINTENENCE

ACCESSORIES

VALVE KIT

SERVICE JOURNAL

UK PATENT PENDING:
PATENT APPLICATION NUMBER 2300221.5

PROTECTOR

DESCRIPTION & FEATURES

WHAT IS PROTECTOR P10?

Protector P10 is a model from our IWTM Protector™ range, a unique side stream filtration device that engineers the system water to a non-corrosive state.

It provides corrosion protection in both new and existing heating and cooling systems, by removing sludge, particles, oxygen and other corrosive products. Therefore the system is maintained in the best possible way, by constantly filtering and engineering the water using electrochemistry and anode technology. The result is that its cleaning and engineering the water at the same time.

NEXT GENERATION OF ELECTROCHEMISTRY

The units provide faster clean-up of old systems and quicker compliance with pre commissioning targets on new systems due to the higher flow rates through the reaction tank (cathode) and the inbuilt ss micron filter that enables finer filtration. The unscreened larger anodes last longer and release the magnesium hydroxide quicker for faster pH control. Compliance with VDI 2035 is still obtained as the anodes sit inside the ss micron filter to capture the magnesium residue when the anodes expire.

- Protector is an "all in one solution"
- Controls the three key parameters of VDI 2035 ; pH, conductivity & dissolved oxygen.
- Creates a hostile environment for bacteria
- Keeps the water clean in closed circulation systems and removes all particles and impurities

PARTICLE FILTRATION

Protector P10 comes as standard with a robust ss micron filter, which is 40 micron nominal. The stainless steel AISI 316, 40µm filter, has a large surface which gives a long operating time before cleaning and thus less flushing and refilling.

Optional bag filters are also available, with a filter degree down to 1 µm.

Please note: The 40 micron stainless steel filter supplied with the Protector as standard although robust in its manufacturing is a consumable item.

It's life expectancy is dependent on the harsh environment it has to deal with when being used to clean existing systems and therefore is not covered by any warranty. On a new system it is possible that the filter can last for many years, but on clean-up project it may only last for a few months.

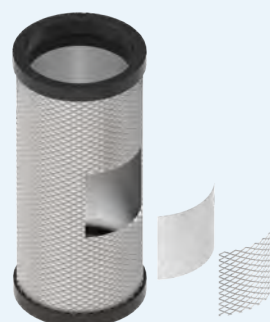

2-Layer S.S Filter



Bag Filter

DESCRIPTION & FEATURES

NEODYMIUM MAGNETS

The Protector P10 comes with two, double piece, short dry, powerful magnets. These are mounted in the centre of the ss micron filter and in front of the sacrificial anodes so that magnetite is captured and not deposited on the anodes, also preventing the ss micron filter basket from clogging up with magnetite. This provides longer service intervals as well as increased operational life and better function. When the magnets are lifted out, all magnetite will be released and can be drained out.



SACRIFICIAL ANODES

Magnesium anodes that provide anodic water treatment and lower the fluid's conductivity.

The anodes also scavenge oxygen and regulate the pH level.

For longer life expectancy, the anodes are encapsulated by a stainless steel micron filter, removing the need for individual anode screens.

WALL OR FLOOR FIXING SYSTEMS

The Protector P10 can easily be installed on the wall. The compact wall mounting bracket allows the unit to be fixed on the wall to save space in situations where space is important and limited. The system is included as a standard feature in the Protector P10.

The wall fixing bracket and nuts are completely in stainless steel, very robust and resistant.



When wall space is not available, the Protector P10 can be fixed with the floor mount bracket as an alternative.

INSTALLATION

SIDE STREAM INSTALLATION USING EXISTING PUMP

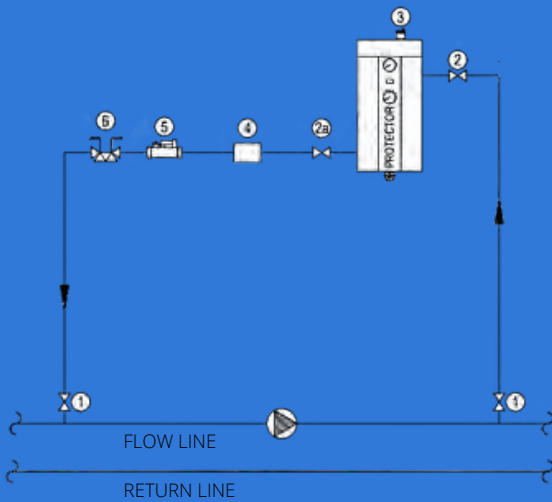

KEY

- 1. CLIENT IV's NOT SUPPLIED
- 2. DRAIN COCK LEVER IV MALE & FEMALE
- 2a. LEVER IV MALE & FEMALE
- 3. 551 CALEFFI UNIT AIR VENT
- 4. MECHANICAL WATER METER
- 5. PICV
- 6. FLUSHING BY-PASS FOR RESIN RINSING

Protector P10 is to be mounted in a “bypass” installation over an existing circulation pump. (Separate circulation pump can be used if needed.)

-Pressure side on pump should be to the inlet on Protector P10 unit.

-Suction side on pump should be to the outlet on the Protector P10 unit.



INSTALLING CONNECTIONS

- 2 pc 1” Female Connections (inlet / outlet)
- 2 pc 1” Plugs (for connections not in use.)
- 2 pc 1” Ball Valves
- 2 pc 1” Plugs
- 1 pc 1” Flowmeter
- 1 pc 1” PICV
- 1 pc 1/2” Air Vent
- 1 pc 1” Drain Valve
- 1 Test Point Valve

Ensure that 800mm clearance is left above the Protector AAV.

Ensure that 600mm clearance is left in front.

INSTALLATION

SIDE STREAM INSTALLATION USING OWN PUMP

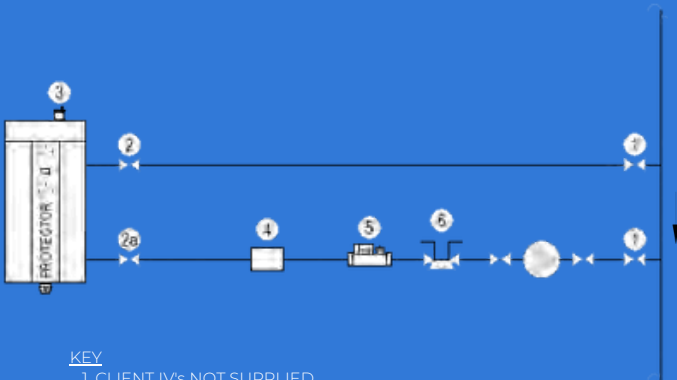

KEY

- 1. CLIENT IV's NOT SUPPLIED
- 2. DRAIN COCK LEVER IV MALE & FEMALE
- 2a. LEVER IV MALE & FEMALE
- 3. 551 CALEFFI UNIT AIR VENT
- 4. MECHANICAL WATER METER
- 5. PICV
- 6. FLUSHING BY-PASS FOR RESIN RINSING



CONNECTIONS

Can be connected:

- IN from either left or right. (only on the top)

-OUT from left or right. (only on the bottom)

-Connections not in use, to be plugged. (1" female threads)

NB:

Top cover/ flange must be according to the water inlet (open and adjust accordingly)

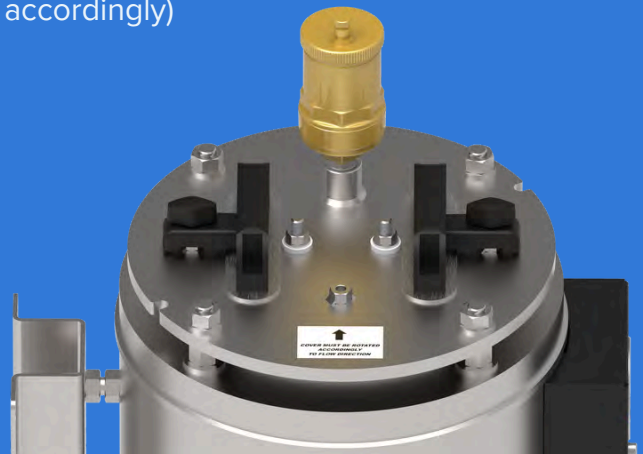

COVER MUST BE ROTATED ACCORDINGLY TO FLOW DIRECTION



Set up for use with left side inlet



Deflector plates



Set up for use with right side inlet

INSTALLATION

INSTALLATION & COMMISSIONING INSTRUCTIONS - PETTINAROLI VALVE

- Close the outlet valve.
- Keeping outlet closed whilst opening the inlet valve.
- Open the automatic air vent.
- Fill the Protector unit once the automatic air vent has dispensed all of the air.
- Open the outlet valve so water flows through the Protector.
- Check the water meter is rotating.
- Set PIC valve as below:

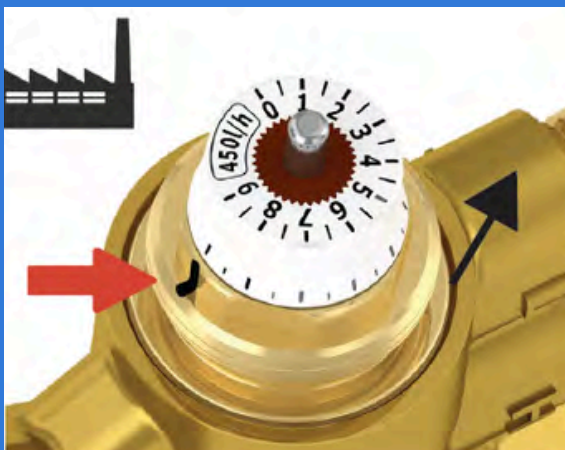

- Remove the handwheel. default setting: position 9

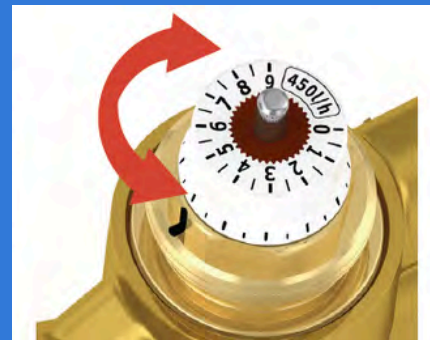

- Turn the selector to the target position to set the flow rate, the settings should be:

Setting 2.5 for 10l/min for the P10

Once you have set this up check the flow rate on the water meter corresponds to required settings on the PICV:

by reading the 0.01 cubic meter dial (=10 litres) , which corresponds to litres per minute.

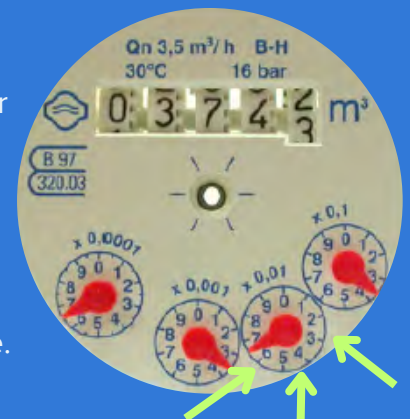

For example it should take 1 minute for the red arrow to read 1 if the setting on the PICV is 2.5 for 10 litres a minute.



- Re-assemble the hand wheel cap with a 3/4" turn to protect the spindle – do not turn more than this or you will push the spindle down and effect the flow rate.

DATA & MEASUREMENTS

PROTECTOR P10 DATA

System Volume: - Max: 10m³ - Heating
7m³ - Cooling

Flow: 10 l/min

Empty Weight: 33KG

Full Weight: 52KG

Shipping Weight: 42Kg

Design Pressure - PN10

Max Temperature - 95°C

Volume of Unit - 20L

Design Code - PED 2014/68/EU

Connection - 1" female thread / BSPP

MATERIALS

Filter House: Stainless steel AISI 304

SS Micron Filter: Stainless steel AISI 316L

Gasket: EPDM

Insulation/Mantling: Armaflex /stainless steel

Anodes: Magnesium

Magnet: Neodymium

Surface Treatment: Brushed stainless steel

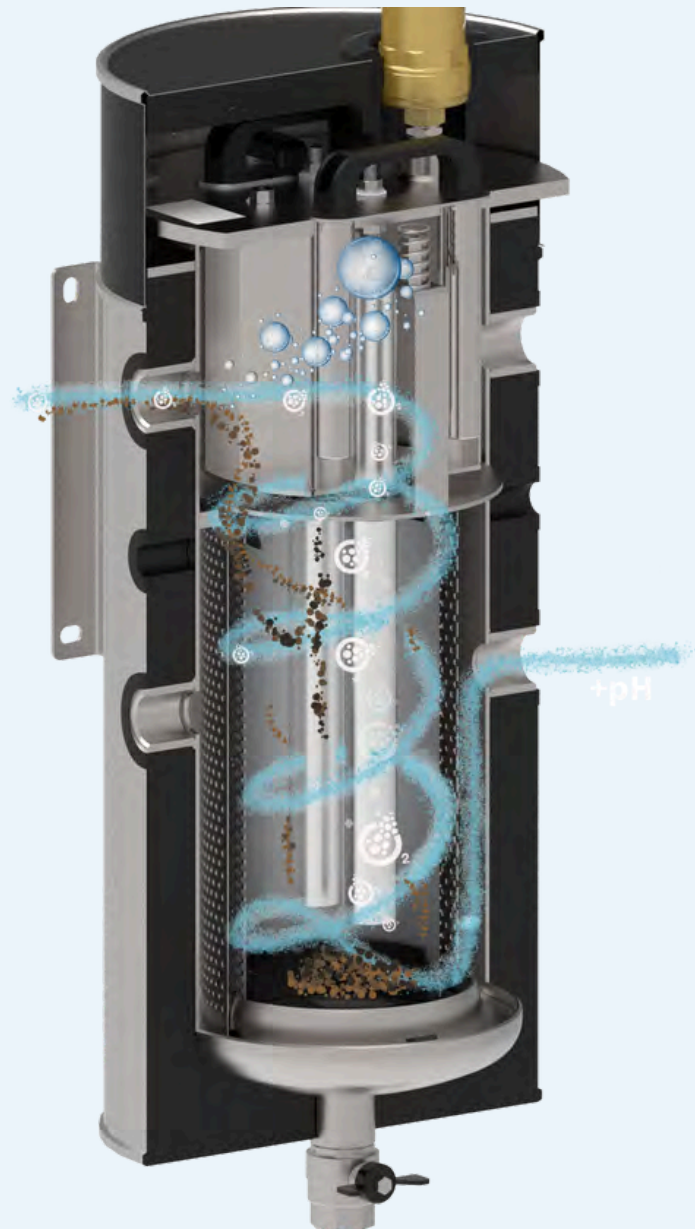

Note: Talk to us for systems that operate at higher pressures or higher temperatures.

DATA & MEASUREMENTS

PROTECTOR P10 - WALL MOUNTING BRACKET

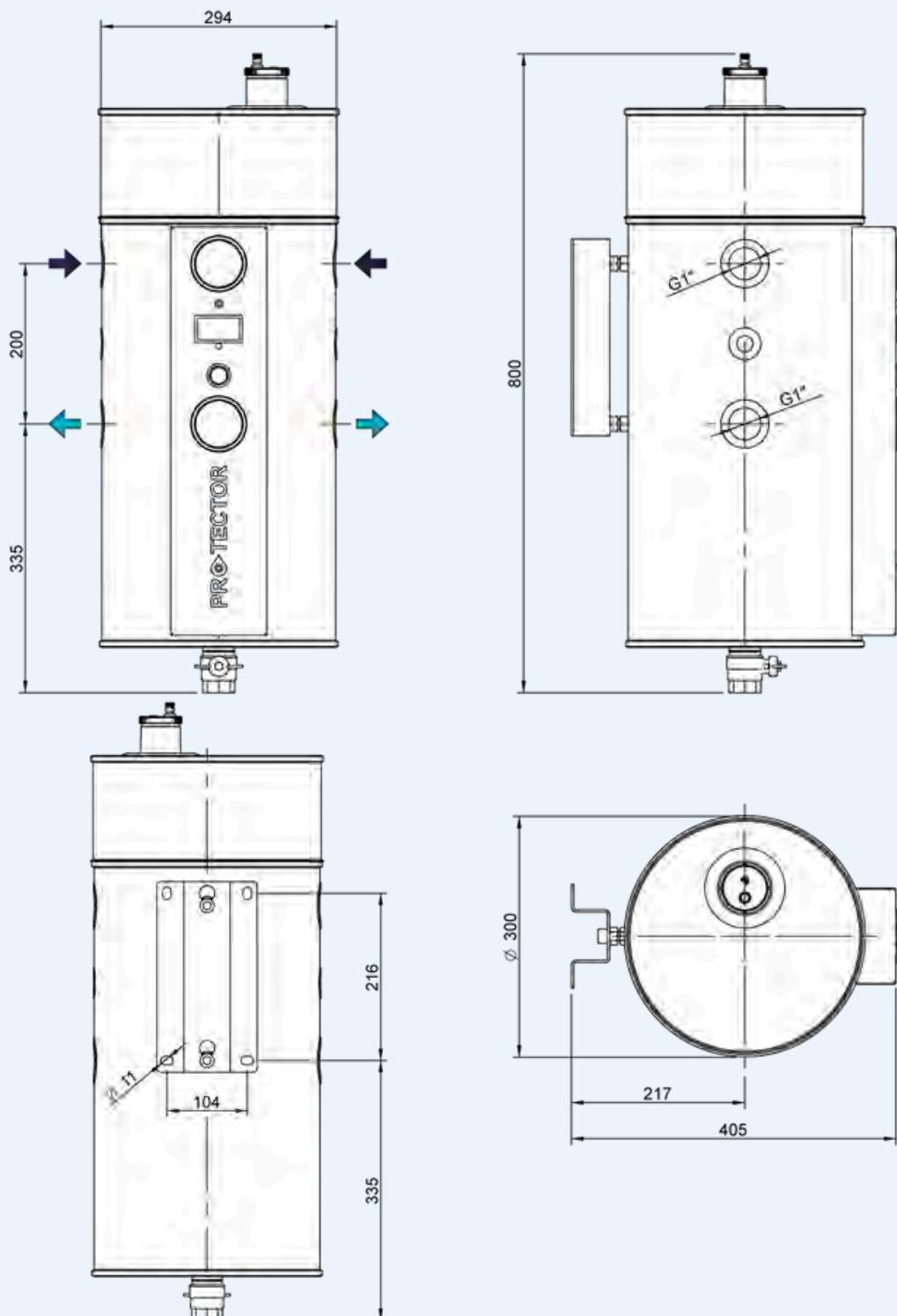

DATA & MEASUREMENTS

PROTECTOR P10 - FLOOR MOUNTING BRACKET

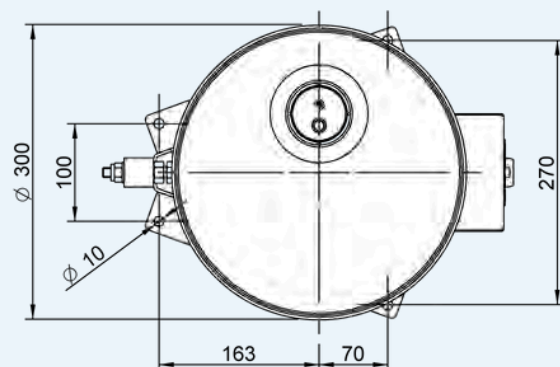
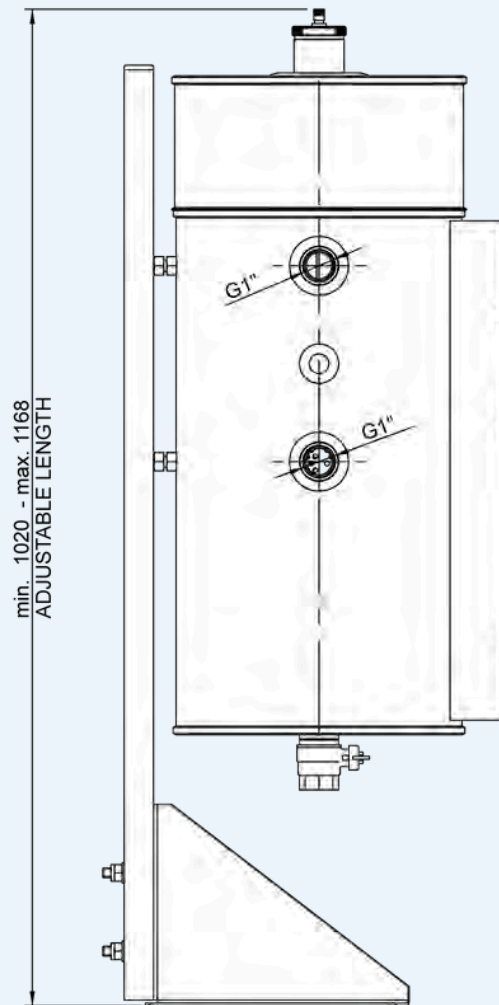
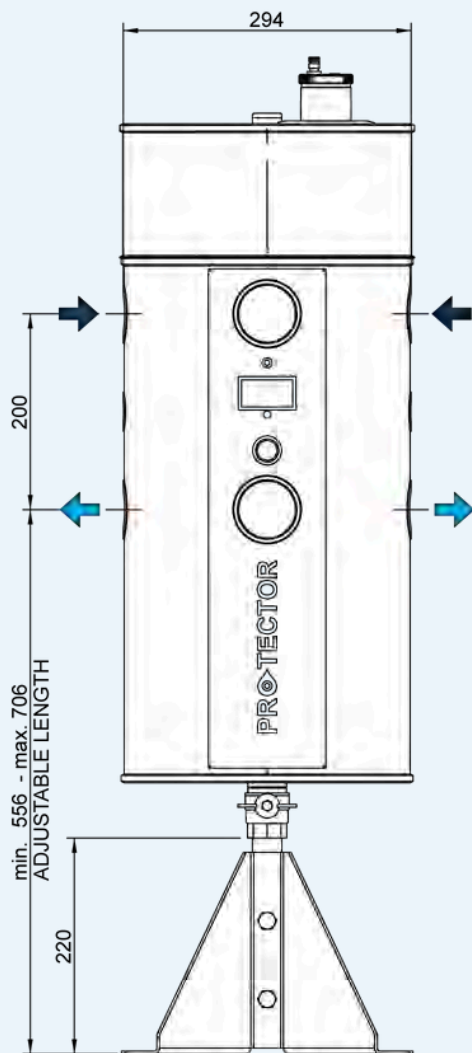

MAINTENANCE

DRAINING

The Protector P10 unit needs to be drained frequently ; how often is dependent on the water quality.

The higher the starting conductivity level, the more sludge there'll be, resulting in a need for more frequent draining.

This is to flush out the sludge and particles that have been collected in the bottom of the tank, from the magnet trap and the ss micron filter .

The magnet in the Protector P10 comes as 2 pieces, shorter double magnets. The magnets are inserted on top of the tank, on the flange lid.

- Close the inlet to the Protector P10.
- Pull out the magnets on top of tank.
- Open the drain valve in the bottom of tank and flush until the water is running clear of debris.
- When complete, close the drain valve and put the magnet back in the sleeve.



MAINTENANCE

ANALOGUE GALVANOMETER & PUSH BUTTON

The analogue galvanometer shows the galvanic current in milliamps between the anodes and the cathode (the tank body), with the system water being the medium.

The analogue galvanometer is always in a continuous reading position ; when the switch is pressed, the instrument is short circuited and shows little or no reading. This function is only for testing the analogue meter itself.

Pure water is non conducting, therefore the more impurities and oxygen in the water the more current will flow between the anode and the cathode.

When the water quality improves, the current diminishes and may measure even as low as 0.2 to 0.3 milliamps when the system water is fully passive.

The Protector P10 system is self-regulating, the anode automatically works harder with corrosive water than with water that is no longer reactive.

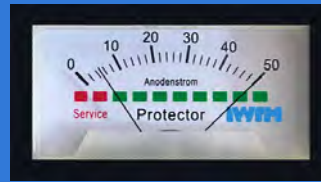

The needle swing lies between 10% and 100%.

This is the normal operating region. The lower the reading, the less the anode needs to work, and the less impurities are in the system water.

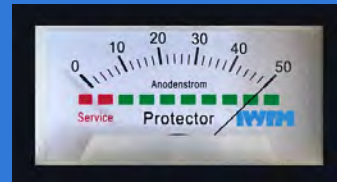

The needle always reads 100%.

The anode is working hard.

If the needle remains in this position for longer than one heating season, the Protector P10 may be undersized for the system.

Action: check the system volume

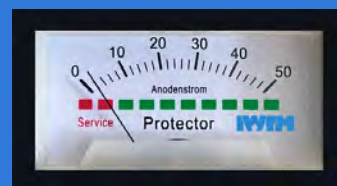

The needle lies continuously close to the red region ;

the needle still drops

to the minimum reading when you press the test button however, the anode no longer needs to work because the chemical reactions in the water have finished, the anode can no longer work because it is coated in a barrier layer or the anode may be close to expiring and needs replacing.

MAINTENANCE

ANALOGUE GALVANOMETER & PUSH BUTTON

Action: remove the sludge from the Protector P10 and fill with fresh water. Keep the isolation valves closed for a day to hold the more corrosive fresh water inside the Protector P10.

After a day, if the operating meter shows a higher reading, everything is operating correctly, and the Protector P10 can be put back into operation. Otherwise, you need to open the lid to inspect the appliance.



The needle drops into the red region within a few weeks.

The anode is spent or coated in a barrier layer or the Protector P10 is isolated from the system and no water is circulating through it.

Action: check circulation or open the appliance and clean or replace the anodes.

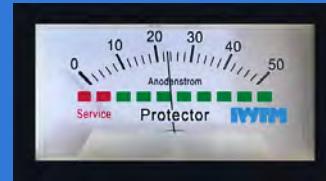

The meter continues to show a constant reading over a long period.

The operating meter might be faulty.

Action: press the test button to check the meter (the needle should drop to the left).

If there is no change in the needle position, the meter is probably faulty.

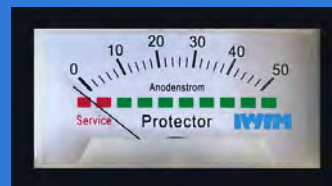

After servicing, if the indicator position is hard left in the red.

If the anode wires are connected wrong, it will create a short circuit and the swing meter will sit in the red zone and will raise up slightly when pressing the test button – to correct this change the two connection wires around on the anode and the earth.

While the Protector P10 is increasing the pH and scavenging oxygen the water gets less aggressive and the current will decrease and stabilise. (normally from 4-15 mA). If some chlorides or sulphates should interfere, resulting in higher conductivity or increased oxygen (feed water), the ampere & output will increase again.

MAINTENANCE

MAGNESIUM ANODES

The filter anodes are in a basket of stainless steel wire mesh called the ss micron filter and do not normally need any cleaning, if however, they are coated in slime from chemical residue or any other debris this can be removed with a suitable scraper to get back to the bare anode surface. Check the anodes for proper functioning (mA instrument).



TOOLS:

- Isolating nut dry side 13 mm spanner
- Isolating bolt wet side 17 mm spanner
- Anode bolt 10 mm spanner
- Flange cover nuts 19 mm spanner

SERVICE

Service on the Protector P10 unit should be done once a year. However, this is also depending upon the quality of the system water.

If there has been an existing problem with sludge, sediments etc. before the Protector P10 installation, we recommend a first service after 3 months of operation. It's also important to take a water sample out of the system, for analysis in a laboratory.

The isolation screw going through the flange has two nylon washers one on each side of the flange. Once opened, they cannot be reused. These washers are not part of the replacement kit. So please **do not** undo the isolation screw.

Make sure not to rotate the bolt while changing the anode. Use a 17mm spanner to hold the isolation bolt securely whilst removing/fitting the anode bolt with a 10mm spanner. This will ensure the isolation screw does not turn. Once the anode has been replaced, use a test meter to check there is no continuity between the anode & the flange. The two isolation washers have two functions 1. To create a watertight seal 2. To electrically isolate the anode from the tank.

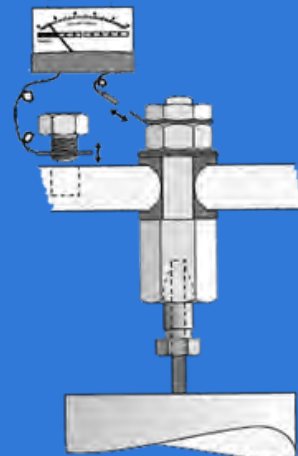

MAINTENANCE

SERVICE

- Close the inlet and outlet ball valves.
- Unscrew the air vent and empty the tank through the drain valve.
- Unscrew the flange lid.
- Carefully lift up the lid, the anodes are attached to the underside.
- Check the anodes and the magnesium rods.
- Flush the anodes, if the magnesium is below 10mm diameter, replace with new ones.
- Take out the ss micron filter and flush / clean.
- Clean the tank inside using a hose or a pressure gun.
- Check all parts belonging to the Protector P10 and clean them if required. (AAV, flowmeter, PICV etc.)

When replacing the anode hold the isolation screw going through the flange and unscrew only the small inner screw at the end of the steel core of the anode. After mounting a new anode, make sure that all screws are tight and that the electrical wiring is properly reinstalled. If there's no indication on the meter, the Protector P10 is not working, so please check the wiring is correct.

When done, put everything back in place and fill up the Protector P10 on the inlet. When the air vent stops letting out air, the tank is refilled and you can open the outlet and start the circulation again. Check that the flowmeter is running.

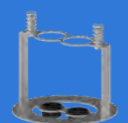

MAINTENANCE

PARTICLE FILTER

Inside the Protector P10 unit is installed a ss micron filter, to catch and remove all sediments and particles.

- The ss micron filter is locked with a small metal clip in the bottom.
- Just twist the ss micron filter slightly to the top left and lift it out.
- Clean the ss micron filter with a water hose.
- Make sure all particles are removed from the ss micron filter .

When done just put it back, turn it slightly to the right and its locked again



(AISI 316 with
40µm ss micron
filter)



Part No.	Description
Protector - Complete Units	
FZPRBG032	PROTECTOR P10 ANALOG 1" F WITH UK VALVE KIT
AMGMB0003	V STOOL
Protector - Bag Filters	
CABAGO011	FELT BAG PES SIZE 01 Ø 178 x L 419 mm 1µm
CABAGO012	FELT BAG PES SIZE 01 Ø 178 x L 419 mm 5µm
CABAGO013	FELT BAG PES SIZE 01 Ø 178 x L 419 mm 10µm
CABAGO014	FELT BAG PES SIZE 01 Ø 178 x L 419 mm 25µm
Protector - Stainless Steel Strainers	
AMCRTO036	2LAY INOX SS MICRON FILTER SIZE 6, 40MM
Protector - Spare Parts	
CDGRN0004	HOUSING GASKET Ø219.1 (EPDM)
CDGRN0020	BAG HOLDER GASKET (EPDM)
101564	ANODE SET NO MESH - P10
CASCM0015	AIR VENT
100078	ANALOG INDICATOR



VALVE KIT

The Protector P10 is supplied with the following valve kit which is packed inside the main Protector P10 box.





Founded in 1992, IWTM have been working with chemical free water treatment using electrochemistry for over 30 years and have offices in Norway, UK, Finland, Sweden, Canada, USA and a worldwide presence in the Marine sector.

We have developed models specifically suited to the higher demands of the marine industry operating at higher pressures and higher temperatures. The marine products are provided worldwide on the world's largest cruise ships working with the leading operators in this sector.

Having secured DNV approval in 2003, we are still the only chemical free water treatment manufacturer to have this certification and approval. DNV is a globally leading quality assurance and risk management company operating in more than 100 countries.

The IWTM Protector™ is our most recently developed product. The Protector range is now available to our land-based customers.

Version 8: July 2024

In line with continued product development we reserve the right to make any changes to this document without any given notice.

PROTECTOR



SUTTON BUSINESS CENTRE
RESTMOR WAY
WALLINGTON SM6 7AH

WWW.IWTM-UK.COM
T: +44 208 255 2903
E: INFO@IWTM-UK.COM