

IWTM PROTECTOR[®] P12- P80 MANUAL



WWW.IWTM-UK.COM
T: +44 208 255 2903
E: INFO@IWTM-UK.COM

TABLE OF CONTENTS

03	DESCRIPTION & FEATURES
06	INSTALLATION
10	PRESSURE SENSOR KIT
11	GALVANOMETER FOR BMS
12	DATA & MEASUREMENTS
14	MAINTENANCE
21	AUTOMATIC AIR VENT
22	SERVICE
23	ACCESSORIES
24	VALVE KIT
25	HP VALVE KIT
26	WARRANTY CONDITIONS
27	SERVICE JOURNAL

NEXT GENERATION OF ELECTROCHEMISTRY

DESCRIPTION & FEATURES

WHAT IS IWTM PROTECTOR® P12-P80

The IWTM Protector® P12 to P80 is a range of unique side stream filtration devices that engineers the system water to a non-corrosive state.

It provides corrosion protection in both new and existing heating and cooling systems by removing sludge, particles, oxygen, and other corrosive products. Therefore, the system is maintained in the best possible way by constantly filtering and engineering the water using electrochemistry and anode technology. The result is that it is cleaning and engineering the water at the same time.

The units provide faster clean-up of old systems and quicker compliance with pre-commissioning targets on new systems due to the higher flow rates through the reaction tank (cathode) and the inbuilt stainless-steel micron filter that enables finer filtration. The unscreened larger anodes last longer and release magnesium hydroxide more quickly for faster pH control. Compliance with VDI 2035 and UK TM20 is still achieved, as the anodes sit inside the stainless-steel micron filter to capture the magnesium residue when the anodes expire.

- IWTM Protector® is an "all in one solution"
- Controls the three key parameters of VDI 2035 and UK TM20; pH, conductivity & dissolved oxygen.
- Creates a hostile environment for bacteria
- Keeps the water clean in closed circulation systems and removes all particles and impurities

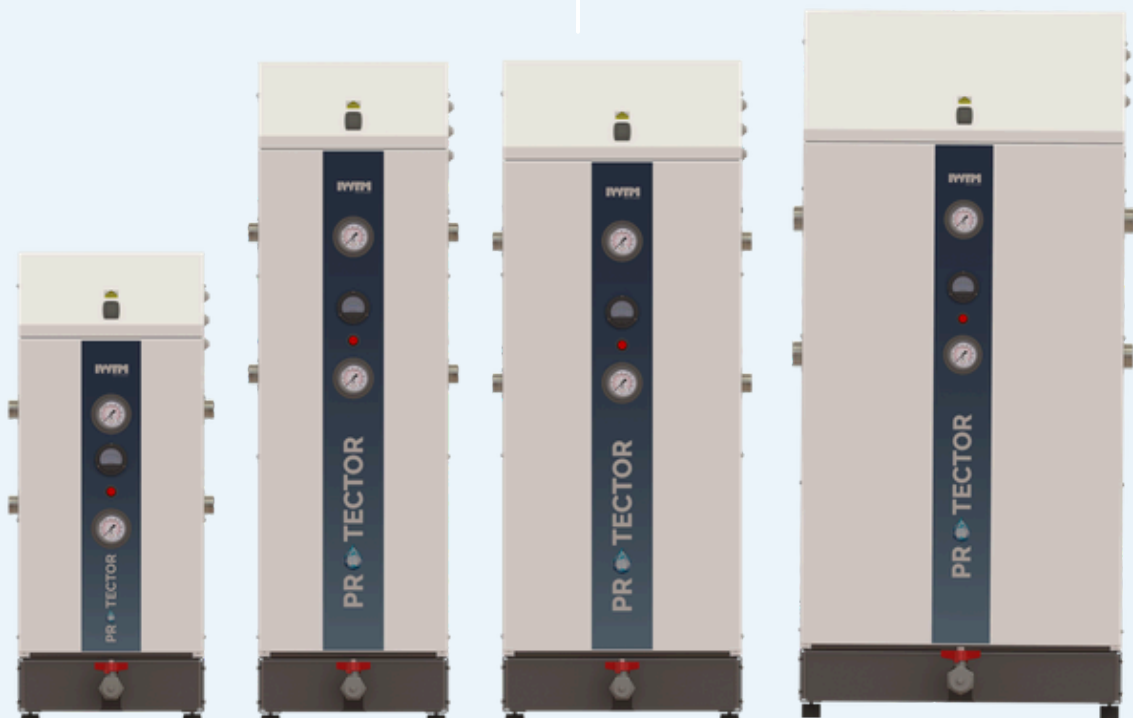

DESCRIPTION & FEATURES

PARTICLE FILTRATION

If there is a difference in the readings on the manometer gauges on the front of the IWTM Protector® the unit will need blowing down or the filter will need removal and cleaning.

IWTM Protector® comes as standard with a robust stainless steel (SS) micron filter, which is 40 microns nominal.

The stainless steel AISI 316, 40 µm filter has a large surface area, providing a long operating time before cleaning and therefore requiring less flushing and refilling.

Optional bag filters are also available, with a filtration degree down to 1 µm.

Please note: The 40 micron stainless steel filter supplied with the IWTM Protector® as standard although robust in its manufacturing is a consumable item.

It's life expectancy is dependent on the harsh environment it has to deal with when being used to clean existing systems and therefore is not covered by any warranty. On a new system it is possible that the filter can last for many years, but on clean-up project it may only last for a few months.

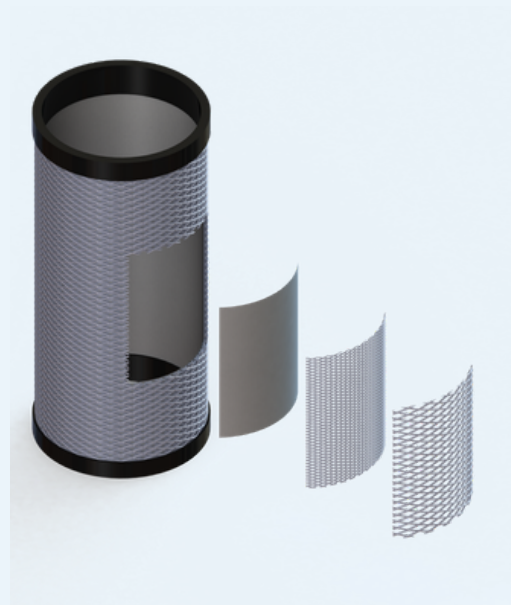

2-Layer Stainless Steel Filter

Our Filter is provided as standard with two layers of stainless steel mesh and can have up to three layers for specialised applications.



Bag Filter

DESCRIPTION & FEATURES

NEODYMIUM MAGNETS

Each IWTM Protector® in the P12-P80 range comes with one long, dry, powerful magnet. This is mounted in the centre of the stainless steel (SS) micron filter and in front of the sacrificial anodes, ensuring that magnetite is captured and not deposited on the anodes, while also preventing the SS micron filter basket from clogging with magnetite. This design provides longer service intervals, increased operational life, and improved performance. When the magnet is lifted out, all captured magnetite is released and can be drained away.

SACRIFICIAL ANODES

Magnesium anodes that provide anodic water treatment to scavenge the oxygen, regulate the pH and lower the fluid's conductivity.

For longer life expectancy, the anodes are encapsulated by a stainless steel micron filter, removing the need for individual anode screens.

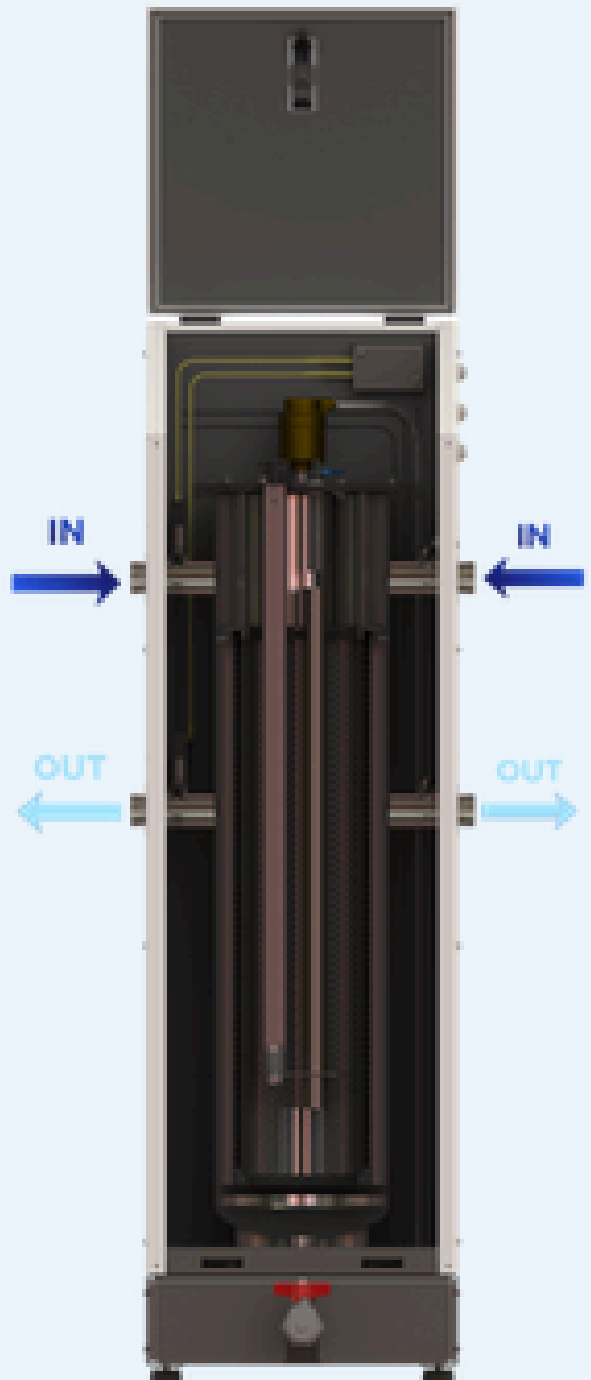

INSTALLATION

SIDE STREAM INSTALLATION USING EXISTING PUMP

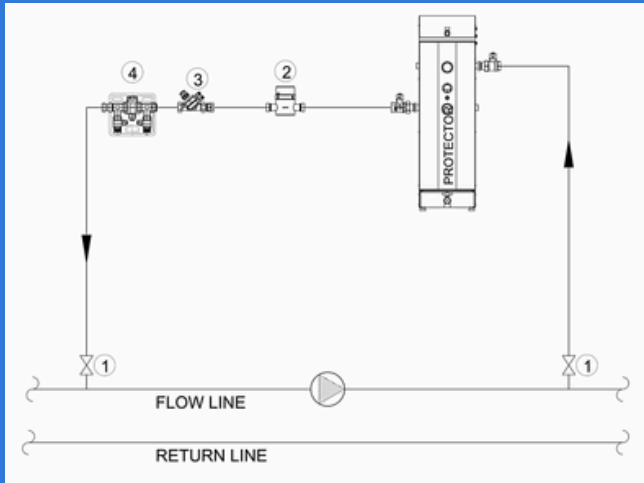

KEY

1. CLIENT IV's NOT SUPPLIED
2. MECHANICAL WATER METER
3. PICV (PRESSURE INDEPENDENT CONTROL VALVE)
4. FLUSHING BY-PASS

IWTM Protector® P12-P80 are designed to be mounted in a bypass installation over an existing circulation pump. (A separate circulation pump can be used if required.)

- Pressure side on pump should be to the inlet on IWTM Protector® unit.
- Suction side on pump should be to the outlet on the IWTM Protector® unit.
- 2 no MXF BSP street elbows are provided with the kit if you need to change the direction of the inlet and outlet connections.

SIDE STREAM INSTALLATION USING OWN PUMP

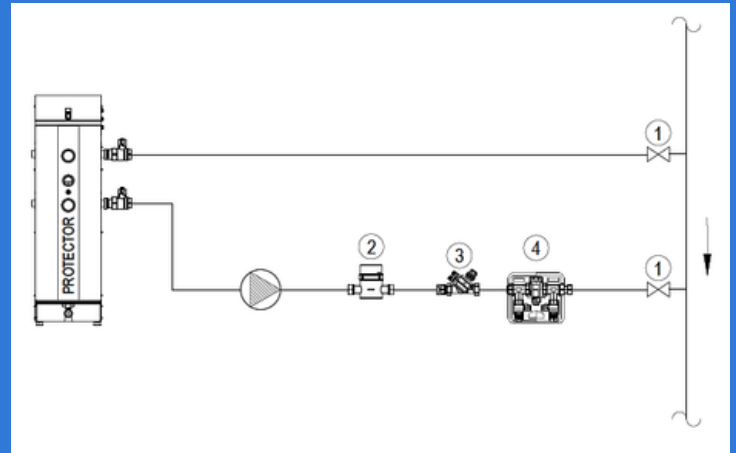

KEY

1. CLIENT IV's NOT SUPPLIED
2. MECHANICAL WATER METER
3. PICV (PRESSURE INDEPENDENT CONTROL VALVE)
4. FLUSHING BY-PASS

NOTE

WHEN USING A GRUNDFOS MAGNA 3 PUMP SUPPLIED BY IWTM-UK, ITEM 5 THE PICV IS NOT REQUIRED, AS THE PUMP PROVIDES A FIXED VOLUME FLOW RATE

PUMP SELECTION CHART-P12-P80

Unit	Size	Flow Rate	m ³ /hr	Pump
P12	1"	12 l/min	0.72m ³ /hr	UPS3 15-50/65
P27	1"	27 l/min	1.62m ³ /hr	Magna 3 25-40
P45	1"	45 l/min	2.7m ³ /hr	Magna 3 25-40
P80	1.25"	80 l/min	4.8m ³ /hr	Magna 3 25-80

INSTALLATION

Ensure that 50mm clearance is at the rear.

Ensure that 600mm clearance is left above the highest point of the IWTM Protector®.

Ensure that 600mm clearance is left in front.

Space required to left and the right will be determined by the orientation of the valve kits.

INSTALLING CONNECTIONS P12 TO P45

- 2 pc 1" Female Connections (inlet / outlet)
- 2 pc 1" Plugs (for connections not in use.)
- 2 pc 1" Ball Valves (inlet valve with test point)
- 2 pc 1" Plugs
- 1 pc 1" Flowmeter
- 1 pc 1" PICV
- 1pc 4 Port By-pass Valve
- 1 pc 1" Drain Valve
- 2 x 1" MXF Elbows

INSTALLING CONNECTIONS P80

- 2 pc 1.25" Female Connections (inlet / outlet)
- 2 pc 1.25" Plugs (for connections not in use.)
- 2 pc 1.25" Ball Valves (inlet valve with test point)
- 2 pc 1.25" Plugs
- 1 pc 1.25" Flowmeter
- 1 pc 1.25" PICV
- 1pc 1.25" 4 Port Flushing By-pass Valve
- 1 pc 1.25" Drain Valve
- 2 x 1.25" MXF Elbows

NOTE:

50mm clearance needs to be on top of the 4 Port Flushing By-pass Valve for servicing



INSTALLATION

5 VDC power supply for galvanometer is supplied with the IWTM Protector®.



CONNECTIONS

Can be connected:

- IN from either left or right. (only on the top)
- OUT from left or right. (only on the bottom)
- Connections not in use, to be plugged.

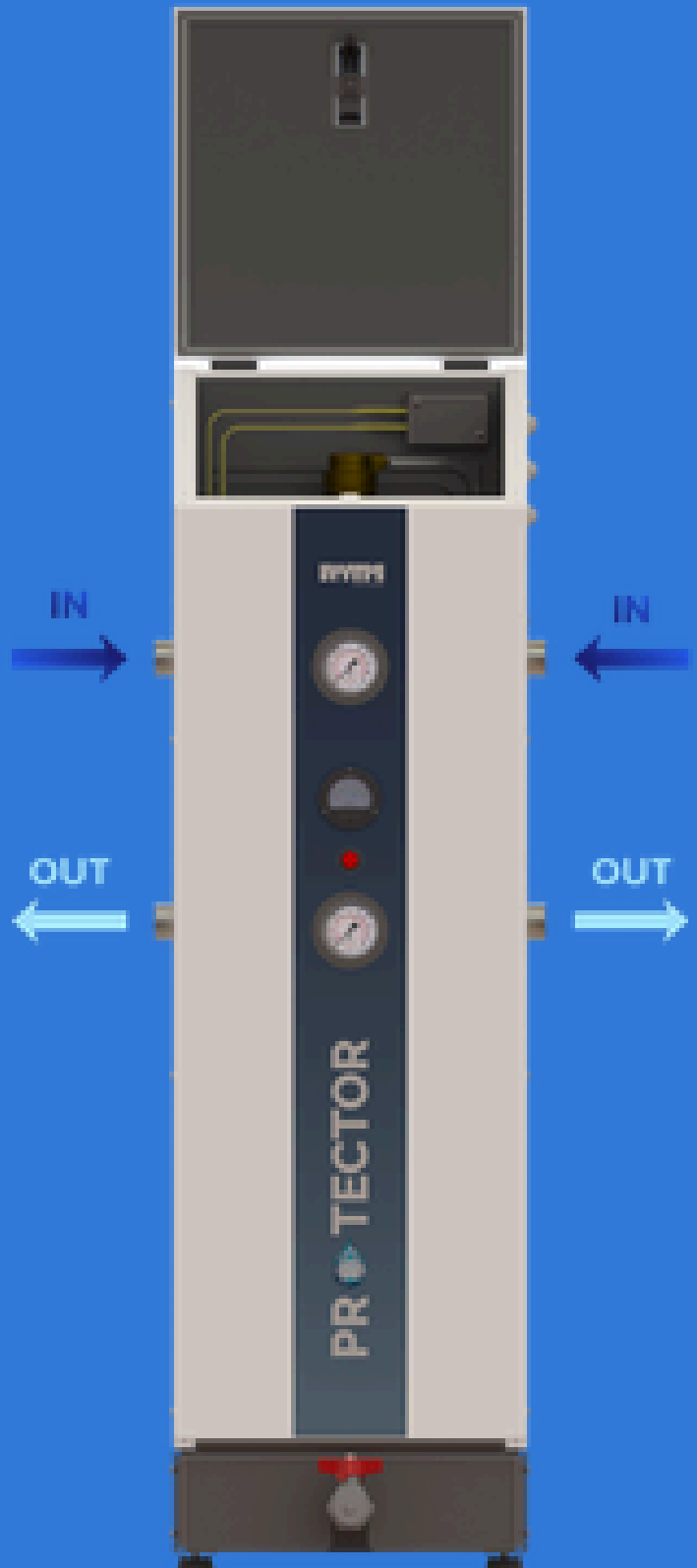

INSTALLATION

INSTALLATION & COMMISSIONING INSTRUCTIONS - PETTINAROLI VALVE

- Close the outlet valve.
- Keeping outlet closed whilst opening the inlet valve.
- Fill the IWTM Protector® unit once the automatic air vent has dispensed all of the air.
- Open the outlet valve so water flows through the IWTM Protector®.
- Check the water meter is rotating.
- Set PIC valve as below:

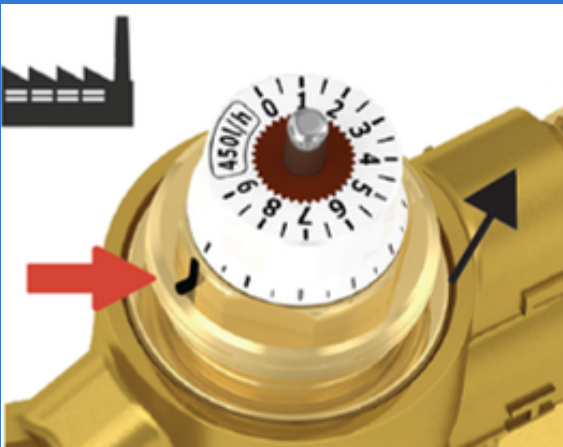

- Remove the handwheel. default setting: position 9



- Turn the selector to the target position to set the flow rate, the settings should be:

PICV SETTING

P12 = 2.5 for 12 l/min

P27 = 4.5 for 27 l/min

P45 = 7 for 45 l/min

P80 = 8 for 80 l/min

Once you have set this up check the flow rate on the water meter corresponds to required settings on the PICV:

by reading the 0.01 cubic meter dial (=10 litres), which corresponds to litres per minute.

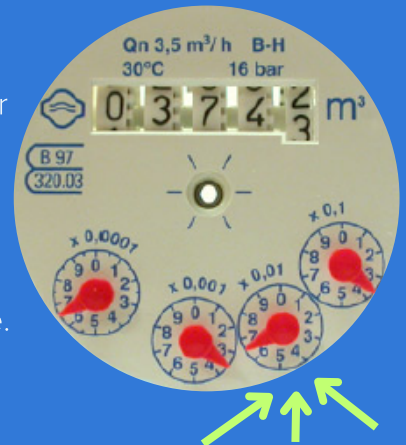

For example it should take 1 minute for the red arrow to read from 0 to 8 if the setting on the PICV is 8 for 80 litres a minute.



Re-assemble the hand wheel cap with a ¾” turn to protect the spindle – do not turn more than this or you will push the spindle down and effect the flow rate.

OPTIONAL PRESSURE SENSOR KIT









SERVICE

The optional pressure sensor kit part number 170150, is to enable the information of pressure differential reading over the internal filter to be sent to a Building Management System (BMS).

- Decide which inlet and outlet connections you will be using.
- Open the case lid and remove the front case by undoing the two internal knurled head bolts, gently move the case forward and before removing it completely disconnect the wiring connector plug on the ammeter.
- Now remove the front case fully and set aside carefully.
- Remove the wiring connector from the top of each sensor by undoing the retaining screws.
- Install the pressure sensors to the ¼” BSP connections on the internal inlet and outlet pipes that you will be connecting to.
- Remove the wiring cover.
- Screw the wiring connector mounting plate into position on the top right-hand corner of the rear panel of the case.

BMS requirements:

- -Power +24V
- -Signal 4..20mA

Optional pressure sensor diagram			
Inlet pressure sensor			+24V from BMS
			Signal back to BMS
Outlet pressure sensor			+24V from BMS
			Signal back to BMS

- Clip in the connector wiring terminal strip with the sensor wires connected.
- Push the sensor wires into the slots in the insulation keeping them tidy.
- Replace the wiring connector to each sensor.
- Use the cable ties to coil up any spare cable.
- Replace the wiring cover.
- Replace the front case and connect the ammeter.
- The sensor wiring connector is now ready for the BMS wiring and can be wired by using one of the cable grommets on the RH side of the case.

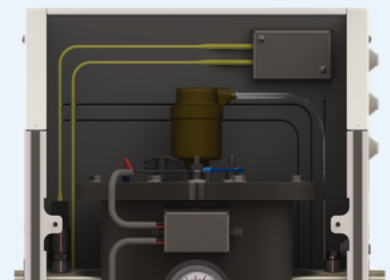
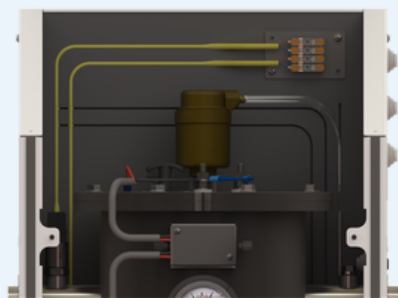

NOTE: The BMS strategy should be set to provide an alarm if the difference between the two sensor readings reaches 0.5 bar.

GALVANOMETER DATA FOR BMS

SERVICE

The galvanometer (swing meter) can be read on the front of the IWTM Protector®; there is an option to read this on the BMS if required.

- Open the case lid and remove the front case by undoing the two internal knurled head bolts, gently move the case forward and before removing it completely disconnect the wiring connector plug on the ammeter.
- Now remove the front case fully and set aside carefully.
- Remove the cover from the galvanometer wiring terminal.

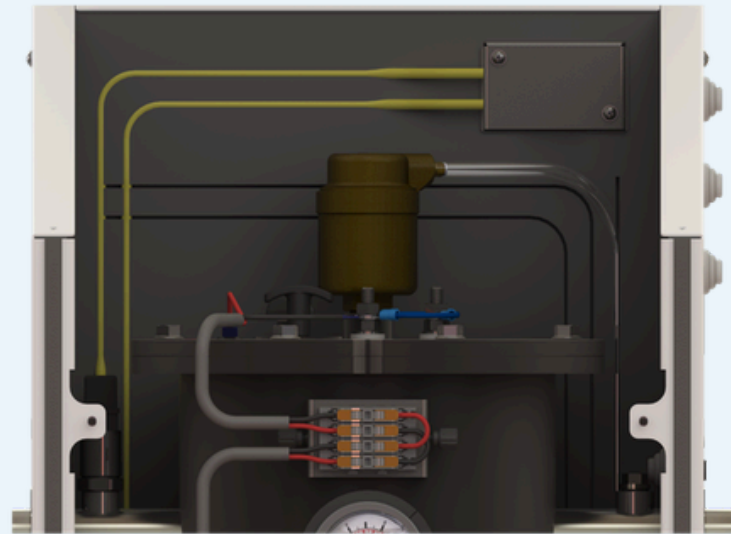

- The red link is the removable link that when removed the two terminals will be wired to the BMS to read a 0-100mA reading.
- Run the BMS cabling to the connections through the cable grommet on the RH side of the case
- Replace the wiring terminal cover.
- Replace the front case and connect the ammeter.

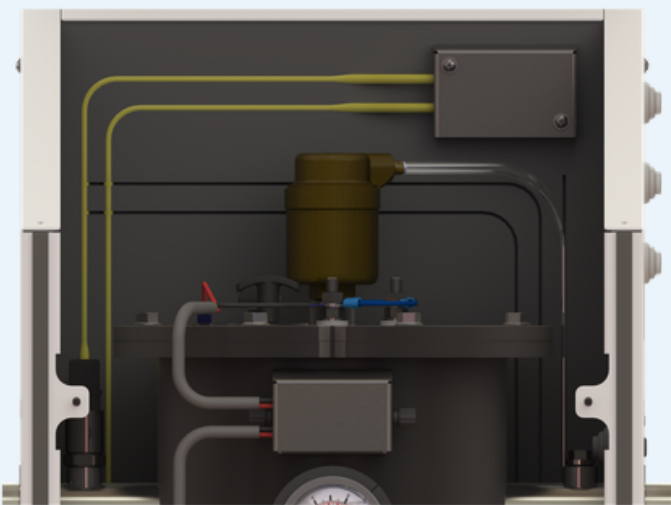

DATA & MEASUREMENTS

IWTM PROTECTOR® P12-P80 DATA

Model	LTHW Volume	CWS Volume	Flow rate	Tank Volume	Dry Weight	Wet Weight	Shipping Weight
P12	12m ³	7.8m ³	12 l/min	17.5 L	60 kg	78 kg	75 kg
P27	27m ³	17.55m ³	27 l/min	29.5 L	80 kg	110 kg	95 kg
P45	45m ³	29.25m ³	45 l/min	66.5 L	110 kg	177 kg	125 kg
P80	80m ³	52m ³	80 l/min	180 L	210 kg	390 kg	235 kg

Design Pressure - PN10

Options - PN25 operating pressure to order

Max Temperature - 95°C

Design Code - PED 2014/68/EU

Connection P12-P45 - 1" female thread / BSPP

Connection P80 - 1.25" Female thread / BSPP

MATERIALS

Filter House: Stainless steel AISI 304

Filter Element: Stainless steel AISI 316L

O ring EPDM: EPDM

Insulation/Cladding: PE Foam / Carbon Steel

Anodes: Magnesium

Magnet: Neodymium

Surface Finishing: Powder Coated



Note: Talk to us for systems that operate at higher pressures or higher temperatures.

DATA & MEASUREMENTS

	A	B	C	D	E	F	G
	Overall height (mm)	Width (mm)	Base depth (mm)	Overall width inc connections (mm)	Total Depth inc drain (mm)	Overall Opening Height (mm)	Opening height in front (mm)
P12	984	390	362	430	481	1351	814
P27	1354	390	360	430	481	1721	1184
P45	1354	490	422	530	541	1786	1158
P80	1518	690	607	730	760	2148	1244

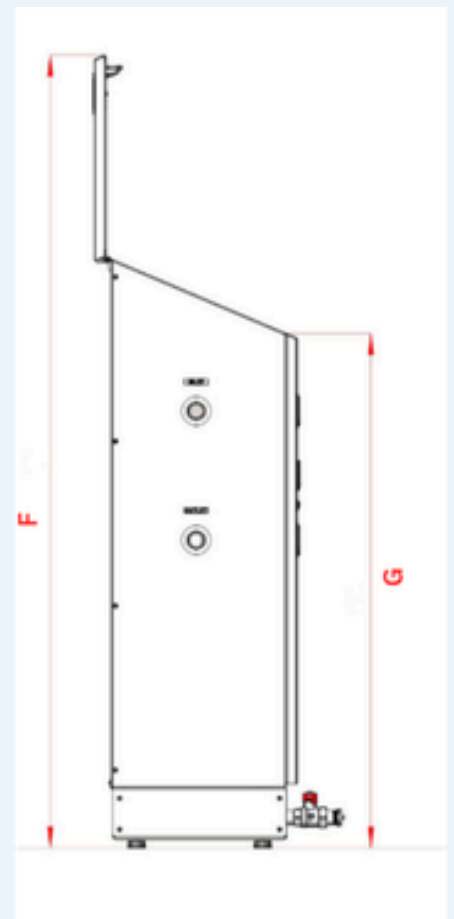
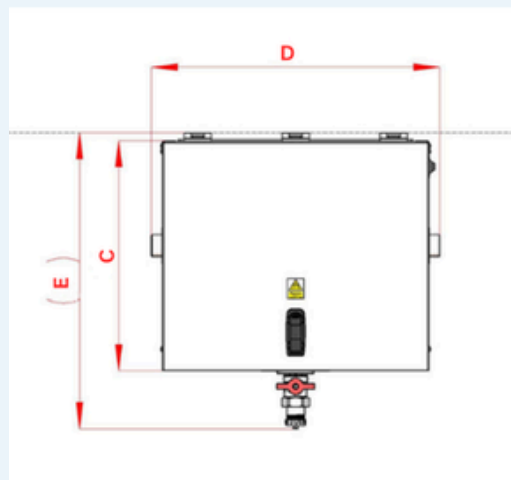
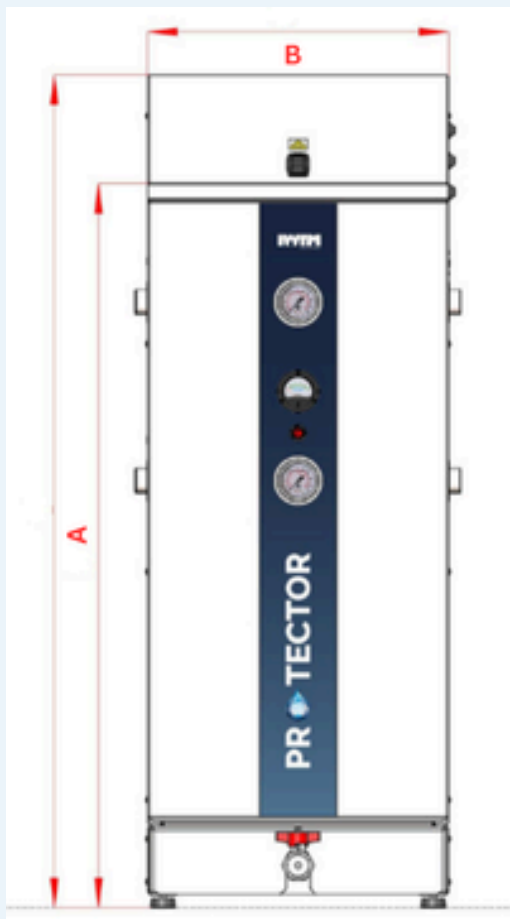

MAINTENANCE

MAINTENANCE, CLEANING AND REPLACEMENT OF THE DIAPHRAGM OF PIC VALVE

During valve cleaning operations, use a damp cloth. DO NOT use any detergent or chemical product that may seriously damage or compromise the proper functioning and the reliability of the valve. Maintenance and cleaning of the differential pressure regulator and the control valve must be carried out as per following instructions, after isolating and draining.

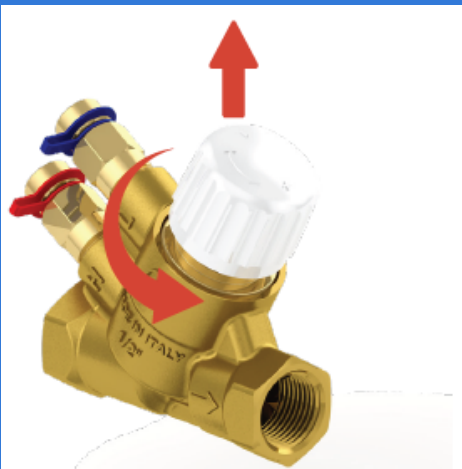

Step 1a: completely remove the knob



Step 2: using a 21mm spanner unscrew the headwork.



Step 3: remove the headwork.



Step 4: push down the control valve stem and pull the diaphragm out



Step 5: clean the diaphragm with water and a cloth

MAINTENANCE

MAINTENANCE, CLEANING AND REPLACEMENT OF THE DIAPHRAGM OF PICV VALVE



Step 6: put back the diaphragm. Push it in its seat



Step 7: replace the headwork



Step 8: screw the headwork with 20 Nm torque



Step 9: replace the handwheel.

MAINTENANCE

DRAINING

The IWTM Protector® P12 to P80 units may need to be drained frequently ; how often is dependent on the water quality.

The higher the starting conductivity level, the more sludge there'll be, resulting in a need for more frequent draining.

This is to flush out the sludge and particles that have been collected in the bottom of the tank, from the magnet trap and the ss micron filter.



The magnet in the IWTM Protectors® P12- P80 comes as a 1 piece magnet. The magnet is inserted on top of the tank, on the flange lid.

- Close the inlet to the IWTM Protectors®.
- Pull out the magnet on top of tank.
- Open the drain valve in the bottom of tank and flush until the water is running clear of debris.
- When complete, close the drain valve and put the magnet back in the sleeve.

MAINTENANCE

ANALOGUE GALVANOMETER & PUSH BUTTON

The analogue galvanometer shows the galvanic current in milliamps between the anodes and the cathode (the tank body), with the system water being the medium.

The analogue galvanometer is always in a continuous reading position ; when the switch is pressed, the instrument is short circuited and shows little or no reading. This function is only for testing the analogue meter itself.

Pure water is non conducting, therefore the more impurities and oxygen in the water the more current will flow between the anode and the cathode.

When the water quality improves, the current diminishes and may measure even as low as 0.2 to 0.3 milliamps when the system water is fully passive.

The IWTM Protector® P12- P80 system is self-regulating, the anode automatically works harder with corrosive water than with water that is no longer reactive.



The needle lies between 10% and 100%.

This is the normal operating region. The lower the reading, the less the anode needs to work, and the less impurities are in the system water.



The needle always reads 100%.

The anode is working hard.

If the needle remains in this position for longer than one heating season, the IWTM Protector® P12- P80 may be undersized for the system.

Action: check the system volume



The needle lies continuously close to the red region ;

the needle still drops

to the minimum reading when you press the test button however, the anode no longer needs to work because the chemical reactions in the water have finished, the anode can no longer work because it is coated in a barrier layer or the anode may be close to expiring and needs replacing.

MAINTENANCE

ANALOGUE GALVANOMETER & PUSH BUTTON

Action: remove the sludge from the IWTM Protectors® and fill with fresh water. Keep the isolation valves closed for a day to hold the more corrosive fresh water inside the IWTM Protectors®.

After a day, if the operating meter shows a higher reading, everything is operating correctly, and the IWTM Protectors® can be put back into operation. Otherwise, you need to open the lid to inspect the appliance.



The needle drops into the red region within a few weeks.

The anode is spent or coated in a barrier layer or the IWTM Protector® P12- P80 are isolated from the system and no water is circulating through it.

Action: check circulation or open the appliance and clean or replace the anodes.



The meter continues to show a constant reading over a long period.

The operating meter might be faulty.

Action: press the test button to check the meter (the needle should drop to the left).

If there is no change in the needle position, the meter is probably faulty.



After servicing, if the indicator position is hard left in the red.

If the anode wires are connected wrong, it will create a short circuit and the swing meter will sit in the red zone and will raise up slightly when pressing the test button – to correct this change the two connection wires around on the anode and the earth.



The rocker switch simply makes the galvanometer go to open circuit to test it is not stuck, when pressed the needle should drop to red zone and come back up when its released.

While the IWTM Protectors® are increasing the pH and scavenging oxygen the water gets less aggressive and the current will decrease and stabilise. (normally from 4-15 mA). If some chlorides or sulphates should interfere, resulting in higher conductivity or increased oxygen (feed water), the ampere & output will increase again.

MAINTENANCE

MAGNESIUM ANODES

The anodes are in a basket of stainless steel wire mesh called the ss micron filter and do not normally need any cleaning, if however, they are coated in slime from chemical residue or any other debris this can be removed with a suitable scraper to get back to the bare anode surface. Check the anodes for proper functioning (mA instrument).



TOOLS:

- Isolating bolt wet side 17 mm spanner
- Isolating bolt dry side 13 mm spanner
- Flange cover nuts are M8 and require a 13 mm socket

SERVICE

Service on the IWTM Protector® P12- P80 unit should be done once a year. However, this is also depending upon the quality of the system water.

If there has been an existing problem with sludge, sediments etc. before the IWTM Protector® P12- P80 installation, we recommend a first service after 3 months of operation. It's also important to take a water sample out of the system, for analysis in a laboratory.

The isolation screw going through the flange has two nylon washers one on each side of the flange. Once opened, they cannot be reused. These washers are not part of the replacement kit.

So please do not undo the isolation screw. Make sure not to rotate the bolt while changing the anode. Use a 17mm spanner to hold the isolation bolt securely whilst removing/fitting the anode bolt with a 10mm spanner. This will ensure the isolation screw does not turn. Once the anode has been replaced, use a test meter to check there is no continuity between the anode & the flange. The two isolation washers have two functions 1. To create a watertight seal 2. To electrically isolate the anode from the tank.

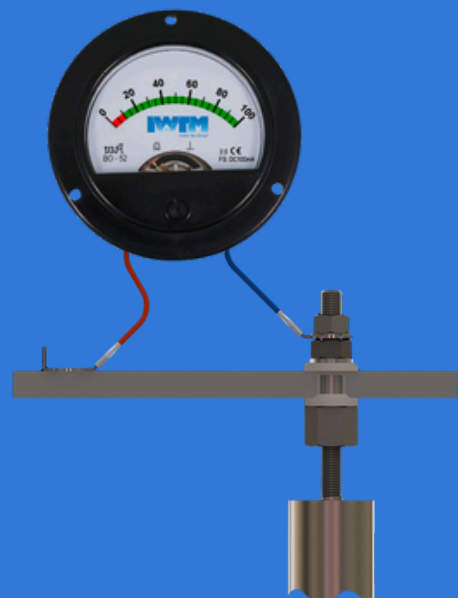

MAINTENANCE

PARTICLE FILTER

Inside the IWTM Protector® P12- P80 unit is installed a ss micron filter, to catch and remove all sediments and particles.

- Lift the ss micron filter out
- Clean the ss micron filter with a water hose or pressure washer
- Make sure all particles are removed from the ss micron filter .
- When done gently replace the ss micron filter.



(AISI 316 with
40µm stainless
steel micron
filter)

MICRON BAG FILTERS

The IWTM Protector® range has a standard 40-micron stainless steel washable filter. It can also use disposable bag filters from 100 µm down to 1 µm. Full list of filters is in the spares list on page 22.



Bag filter

20

P12 to P45:

- Remove the 40-micron stainless filter.
- Leave the outer bag support basket in place (it supports the bag filter).

P80:

- Keep the 40-micron stainless filter in place.
- The bag support basket sits inside the stainless filter, allowing the bag filter to sit inside without removal.
- This design creates double filtration (water passes through the bag filter and then the stainless filter).

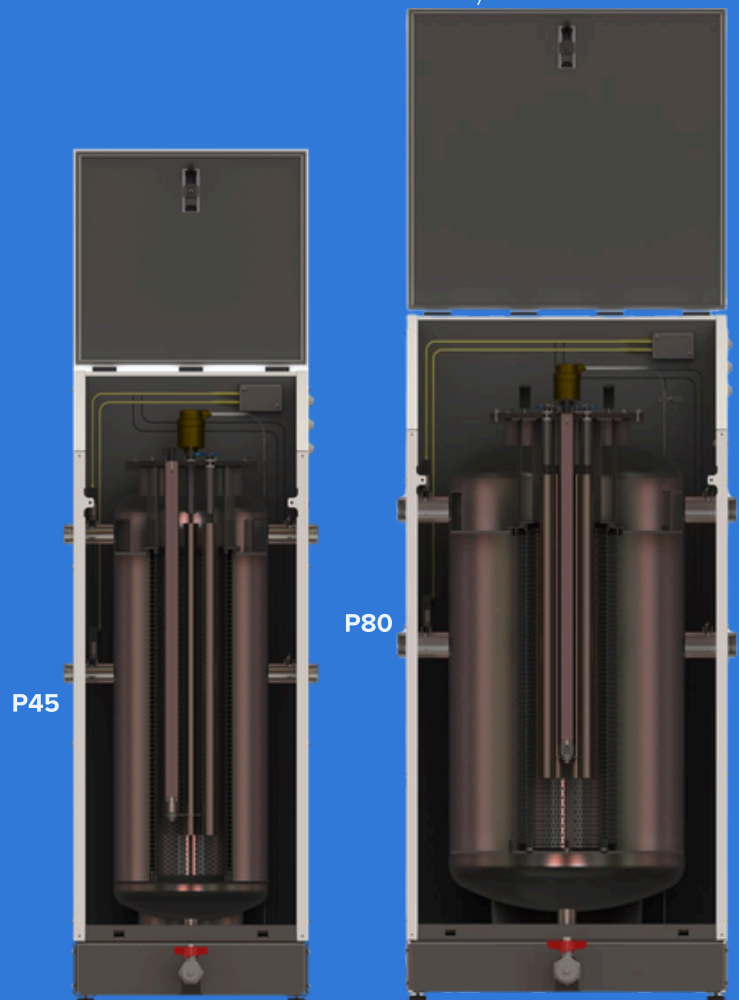

MAINTENANCE

AUTOMATIC AIR VENT VALVE (AAV)

The AAV on the IWTM Protector® P12 to P80 range is designed not to be closed, this is to prevent the build up of air.

- In the event of permanent discharge from the AAV it will be necessary to clean or replace it as follows.
- Isolate the IWTM Protector®
- Disconnect the weep tube line from the AAV.
- Remove the AAV from the IWTM Protector® and turn it upside down as show ideally on a work bench.
- Using a 4mm Allen wrench unscrew the air vent valve. Then proceed with cleaning or replacement (picture 1).
- Wash the AAV through with clean water.
- For correct insertion of the stem on the float, screw with the upper body upside down and the air vent valve horizontal (picture 2).
- Replace the AAV in the IWTM Protector® using suitable industry standard jointing methods.
- Replace the AAV weep tube line.
- Fill and test

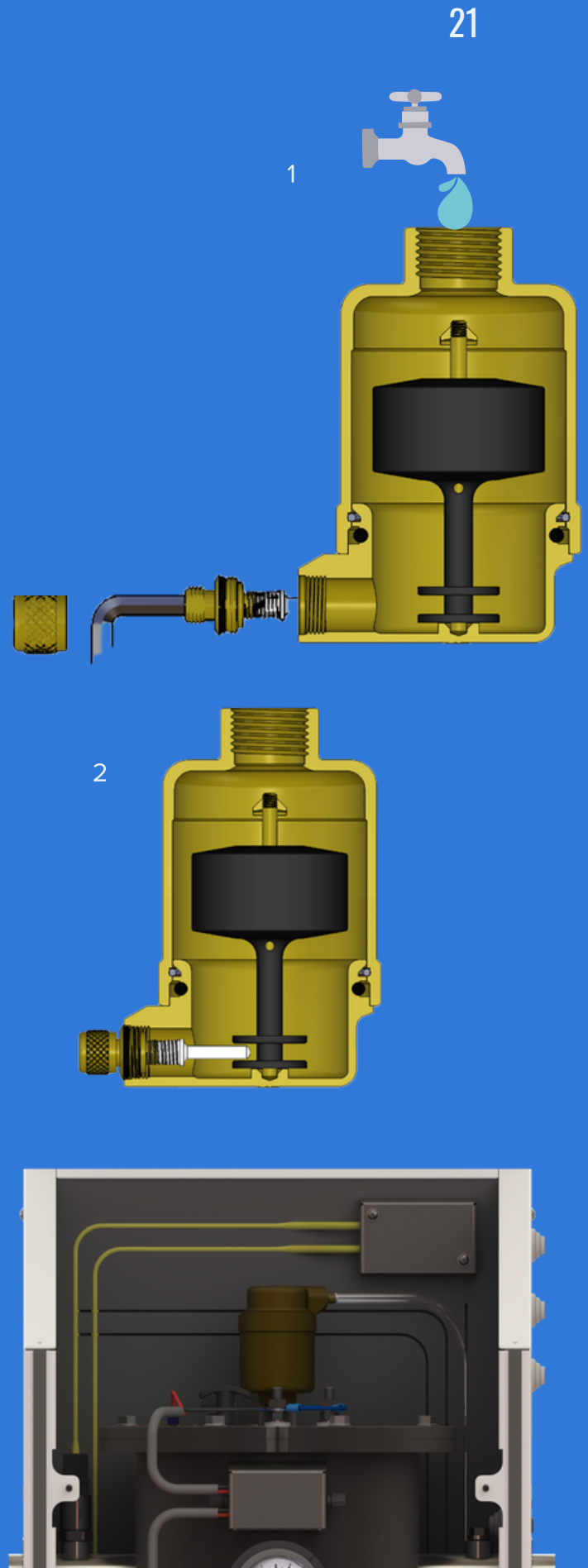

MAINTENANCE

Note: To avoid the potential risk of galling or cold welding which is a phenomenon that can happen when stainless steel threads lock together, in accordance with good engineering practise on the reassembly after any service work an anti seize paste should be applied to the bolt threads. Avoiding the use of power drivers can also reduce the risk of galling as the increased tightening speed creates heat that can accelerate this process.

SERVICE

- Close the inlet and outlet ball valves.
- Empty the tank through the drain valve.
- Unscrew the flange lid.
- Carefully lift up the lid, the anodes are attached to the underside.
- Check the anodes and the magnesium rods.
- Flush the anodes, if the magnesium is below 10mm diameter, replace with new ones.
- Take out the ss micron filter and flush / clean.
- Clean the tank inside using a hose or a pressure gun.
- Check all parts belonging to the IWTM Protector® P12- P80 and clean them if required. (AAV, flowmeter, PICV etc.)
- When replacing the anode hold the isolation screw going through the flange and unscrew only the small inner screw at the end of the steel core of the anode.

- After mounting a new anode, make sure that all screws are tight and that the electrical wiring is properly reinstalled. If there's no indication on the meter, the IWTM Protector® P12- P80 is not working, so please check the wiring is correct.

TORQUE settings:

Anode isolation bolts 25 Nm

Flange bolts 25Nm

When done, put everything back in place and fill up the IWTM Protector® P12- P80 on the inlet. When the air vent stops letting out air, the tank is refilled and you can open the outlet and start the circulation again. Check that the flowmeter is running.

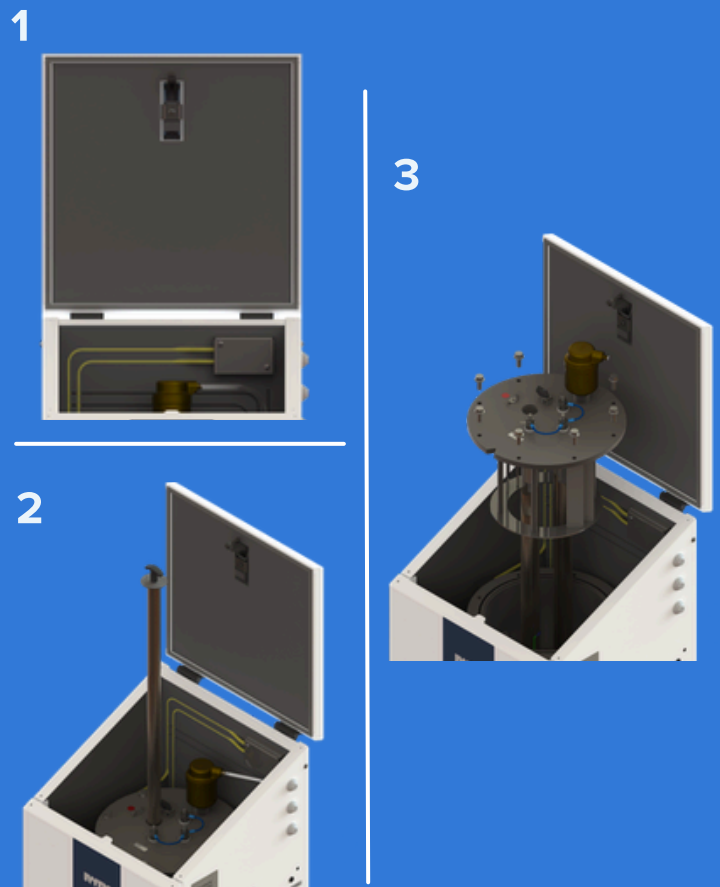

Note: The S/S micron filter is a consumable item its life expectancy depends on how much work it has to do when the IWTM Protector® is being used to clean up old systems.

Part No.	Description
IWTM Protector® - Bag Filters	
210006	P12 Size 1 bag filter – 100 µm
210005	P12 Size 1 bag filter – 50 µm
210004	P12 Size 1 bag filter – 25 µm
210002	P12 Size 1 bag filter – 5 µm
210001	P12 Size 1 bag filter – 1 µm
210013	P27/45/80 Size 2 bag filter – 100 µm
210012	P27/45/80 Size 2 bag filter – 50 µm
210011	P27/45/80 Size 2 bag filter – 25 µm
210009	P27/45/80 Size 2 bag filter – 5 µm
210008	P27/45/80 Size 2 bag filter – 1 µm
IWTM Protector® - Stainless Steel Strainers	
210043	P12 stainless 40 micron filter
210045	P27/P45 stainless 40 micron filter
210047	P80 stainless 40 micron filter
IWTM Protector® - Spare Parts	
170143	Air Vent – FAR AAV ½”
170144	P12 anode isolation bolt kit
170145	P27/45/80 anode isolation bolt kit (special – 82 mm long)
170146	P12 Galvanometer
170147	P27/45/80 Galvanometer
101571	P12 Anode set
101572	P27/45 Anode set
101574	P80 Anode set
170148	P12/27/45 O-RING
170149	P80 O-ring
170150	Pressure Sensor Kit (P12–P80)



VALVE KIT

The IWTM Protector® is supplied with the following valve kit which is packed inside the main IWTM Protector® P12- P80 box.

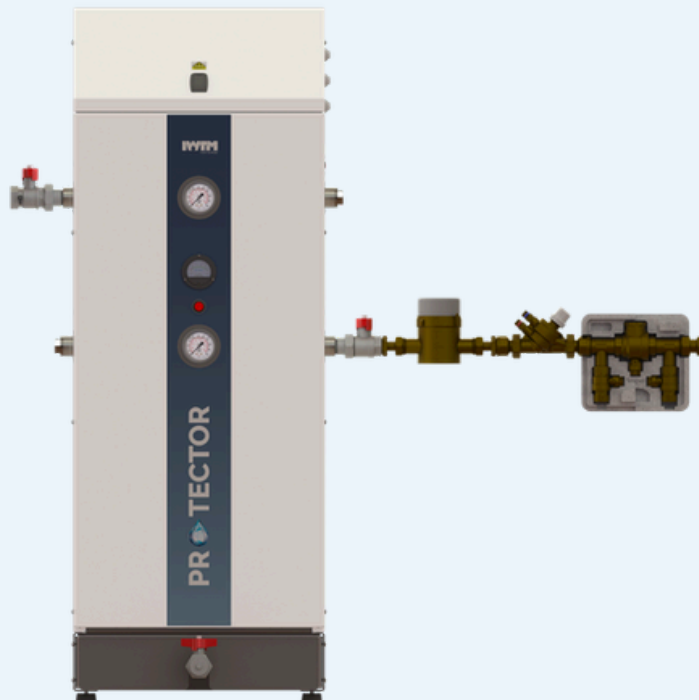
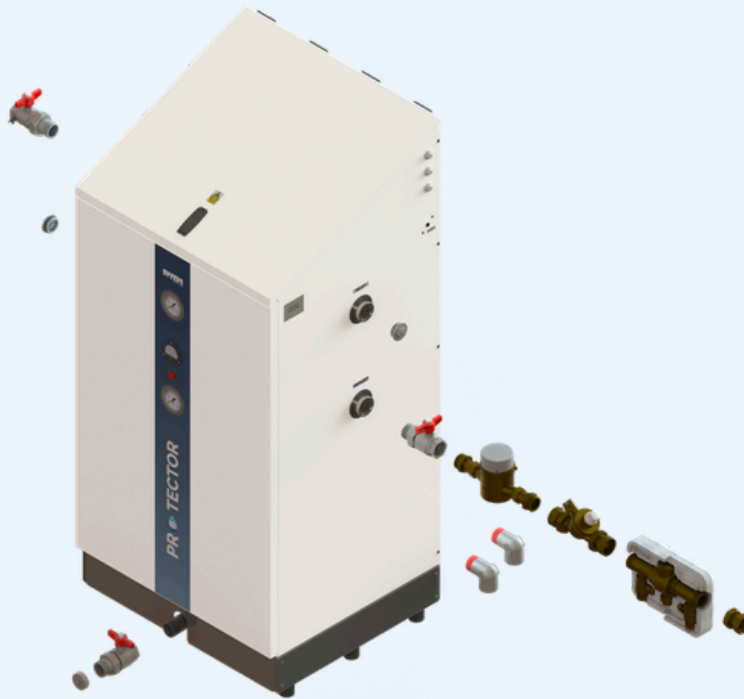

HP VALVE KIT

IMPORTANT:

- The HP Protectors are rated at 25 Bar (PN25). They are supplied with a different valve kit that is only for use with the HP models.
- The fittings including plugs, valves and PICV are rated PN25 and if lost should never be replaced with other products that are not provided as part of the original valve kit.
- The internal factory fitted Spirotech AAV - SpiroTop AAV 0.5in 150deg 25bar is the only AAV to be used on the HP Protector range.
- We do not supply high pressure pumps for the HP Protectors and they are ideally suited for being installed around the main system pumps on side stream.



- DO NOT use valves or components from our standard P12 to P80 range as these are not PN25 rated.
- IWTM-UK will not provide any warranty and will not be responsible for any loss or damages should the above not be adhered to.

WARRANTY CONDITIONS

The stainless steel tank assembly for IWTM IWTM Protector® units, including the IWTM Protector® and ProFill, and the marine units, models T50/T100/T260/T500/T800 and T1000, is guaranteed for a period of 25 years against rusting through. This warranty is subject to the following conditions:

IWTM Protector®/Industrial unit warranties will only be validated if the system is installed, in line with manufacturers recommendations, with an appropriate ProFill demineralising device ensuring that all manual or automatic make up and refill water is demineralised in accordance with VDI2035.

Periodic maintenance must be undertaken at least every 12 months in accordance with our manuals, proven to have been carried out by a specialist service company with clear, documented evidence.

This 25-year warranty only extends to the main tank and not to any supplied accessories, meters, AAV's, anodes, filters, etc. The warranty provides for a replacement unit only and not for labour or any other costs associated with the replacement of the equipment.

PLEASE SEE OUR FULL TERMS AND CONDITIONS ON YOUR
QUOTATION FOR FURTHER DETAILS



Founded in 1992, IWTM have been working with chemical free water treatment using electrochemistry for over 30 years and have offices in Norway, UK, Finland, Sweden, Canada, USA and a worldwide presence in the Marine sector.

We have developed models specifically suited to the higher demands of the marine industry operating at higher pressures and higher temperatures.

The marine products are provided worldwide on the world's largest cruise ships working with the leading operators in this sector.

Having secured DNV approval in 2003, we are still the only chemical free water treatment manufacturer to have this certification and approval. DNV is a globally leading quality assurance and risk management company operating in more than 100 countries.

The IWTM IWTM Protector® is our most recently developed product. The IWTM Protector® range is now available to our land-based customers.

March 2026

In line with continued product development we reserve the right to make any changes to this document without any given notice.

PROTECTOR

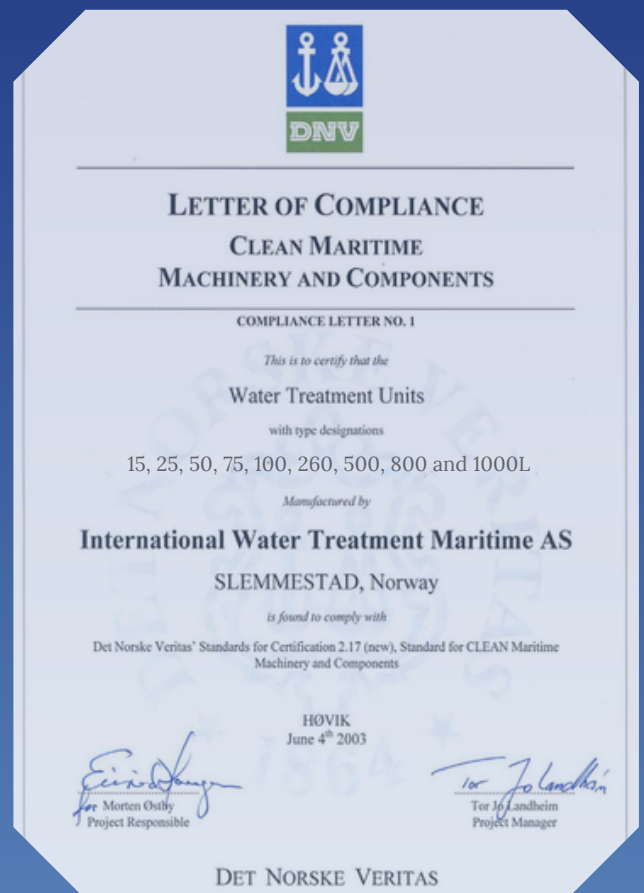

SUTTON BUSINESS CENTRE
RESTMOR WAY
WALLINGTON SM6 7AH

WWW.IWTM-UK.COM
T: +44 208 255 2903
E: INFO@IWTM-UK.COM