

# P120 - P1500 MANUAL



WWW.IWTM-UK.COM  
T: +44 208 255 2903  
E: INFO@IWTM-UK.COM



# TABLE OF CONTENTS

03	DESCRIPTION & FEATURES
05	INSTALLATION
07	DATA & MEASUREMENTS
11	MAINTENANCE
19	ACCESSORIES
20	SERVICE JOURNAL

# DESCRIPTION & FEATURES

## WHAT IS PROTECTOR P120-P1500?

The IWTM Protector is a unique electrochemistry water treatment device in that it has a distinct water path to enhance the filtration and electrochemical reaction, designed to remove the system impurities and to engineer the water to keep it in a non-corrosive state. It provides a “hybrid / multipurpose function” that eliminates the use of chemicals, de-aerators, and magnetic separators, and provides full compliance with VDI 2035 water quality.

The system water enters the upper section of the stainless-steel tank creating a cyclonic effect and the water flow is directed down through a stainless-steel mesh which breaks down micro bubbles, this mesh also forms part of the tank creating a larger surface of cathode. The micro bubbles are driven upwards and are released through an automatic air vent. Dirt and debris drop to the bottom due to the cyclone effect within the tank. 2 dry powerful magnets hold in place any magnetite particles, these will be held in the lower chamber until the Protector is drained or blown down to release and remove them.

Water is then drawn up through a central column via a perforated stainless-steel tube that sits in the centre of the bundle of pure magnesium anodes, this ensures that a good even flow is passed over the anodes at all times, when the water leaves the Protector chamber it is then forced through a high grade 110-micron stainless steel filter before going back into the system having been cleaned and treated.

The micron filter will capture any non-magnetic particles and prevent them from re-entering the system. These particles will be held in the micron filter and will be removed by flushing the external filter when the Protector is blown down and flushed.

Within the central cyclone is where the electrochemistry takes place. The Protector uses pure magnesium bare anodes and with the top filter mesh and tank being connected these two components increase the surface area of the cathode. This increased surface area of cathode produces a higher rate of electrochemical reaction which results in increased cleaning power and superior performance than other devices.

The centralised anode holder is a carousel device and rotates for the ease of changing the anodes, the anode holder is insulated from the tank by lower and upper insulated sleeves which separates the carousel from the tank and prevents the anodes from earthing.

## NEXT GENERATION OF ELECTROCHEMISTRY

- Protector is an "all in one solution"
- Controls the three key parameters of VDI 2035 ; pH, conductivity & dissolved oxygen.
- Creates a hostile environment for bacteria
- Keeps the water clean in closed circulation systems and removes all particles and impurities

In closed systems the installation will be side stream. This provides a method of easy installation, operation and maintenance.

# DESCRIPTION & FEATURES

## NEODYMIUM MAGNETS

Two long, dry, powerful magnets are located in the base of the tank underneath the carousel, designed to capture the magnetite in the base of the tank and preventing the ss micron filter from clogging up with magnetite. This provides longer service intervals as well as increased operational life and better function. When the magnets are pulled out, all magnetite will be released to the bottom of the tank and can be drained out.

## SACRIFICIAL ANODES

The 33mm bare sacrificial anodes consume the dissolved oxygen by the process of corrosion, the fast corrosion rate of the bare anode quickly releases magnesium hydroxide into the water, and this provides an alkaline pH between 8.2 and 10 and the consumption of the dissolved oxygen removes the threat of corrosion from the system water.

## PARTICLE FILTRATION

Protector P120-P1500 comes as standard with an external robust stainless steel micron filter which is 110 micron nominal with the option to go down to 40 and 25 microns.

The external filter is supplied loose but it is a fundamental part of the full range from P120 to P1500 and has to be fitted on the outlet pipe as it forms part of the overall design and operation.

The stainless steel filter has a large surface which gives a long operating time before cleaning and thus less flushing and refilling.

*Please note: The 110 micron stainless steel filter supplied with the Protector as standard although robust in its manufacturing is a consumable item.*

*It's life expectancy is dependent on the harsh environment it has to deal with when being used to clean existing systems and therefore is not covered by any warranty. On a new system it is possible that the filter can last for many years, but on clean-up project it may only last for a few months.*

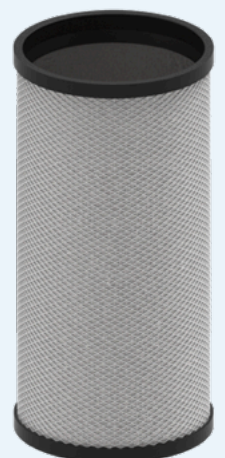

**2-Layer S.S Filter**

# INSTALLATION

## TYPICAL INSTALLATION

Protector is to be installed in side stream application with its own circulating pump.

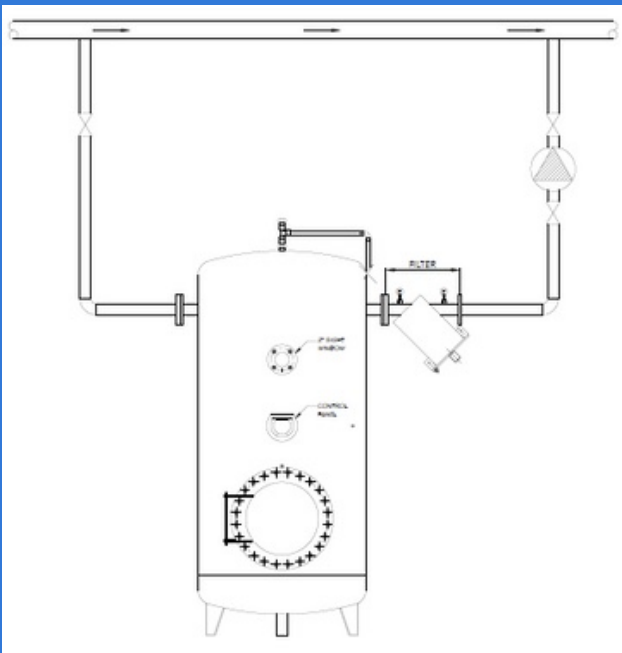

The Protector P120 to P1500 range units are all flanged and we do not provide any valves for installation to the system. The tanks are supplied as standard with the following:

1. 3/4" AAV and 3/4" nipple supplied loose for safe transit purposes to be installed on site as part of the installation process.
2. Drain valve factory fitted.
3. Anti vacuum/fill valve and pipework supplied loose for safe transit purposes to be installed on site as part of the installation process.
4. External outlet filter which has to be installed on the outlet as it forms part of the functional operation of the tank. The weight of the filter has to be supported using correct installation and support methods.
5. Brannan thermometer + dry pocket supplied loose .

Optional supply by IWTM:

1. Grundfos Magna 3 smart pump sized to the Protector model

In addition we recommend the following is installed on site:

1. Either a mechanical or ultra sonic water flow meter to record the hours run of the Protector – This is used between service visits to monitor the operational time of our unit and the volume of water passed and therefore treated.
2. Or instead of a water meter the Building Management System(BMS) has the capability of recording the hours run and volume passed.

Our preferred pump selection is Magna 3 range from Grundfos, so the flow rate can be set and visually seen on the pump display. Alternative pumps that have the same functionality and can meet the same requirements can also be used.

### Pump Selection Chart

Unit	Flow Rate	Connection Size	m <sup>3</sup> /hour	Pump
P120	100l/min	DN40	6	Magna 3 40-80
P220	160l/min	DN40	9.6	Magna 3 40-80
P300	200l/min	DN50	12	Magna 3 50-120
P600	400l/min	DN65	24	Magna 3 65-80
P900	600l/min	DN80	36	Magna 3 80-60
P1200	800 l/min	DN100	48	Magna 3 100-80
P1500	1000l/min	DN100	60	Magna 3 100-100

# INSTALLATION

## BMS CONNECTION FOR GALVANOMETER

The anode output is read between 0 and 100ma on the galvanometer – This can also be read on a BMS system.

The wiring behind the front control panel is BMS ready. To read the output on your BMS simply remove the large black removable link shown in the photo attached and the wiring diagram and connect these connections to your BMS.

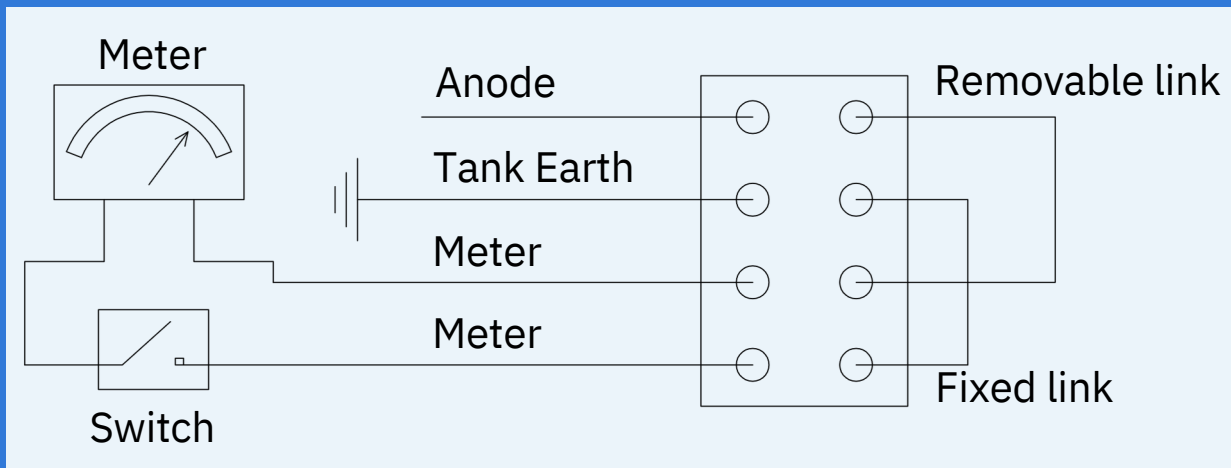
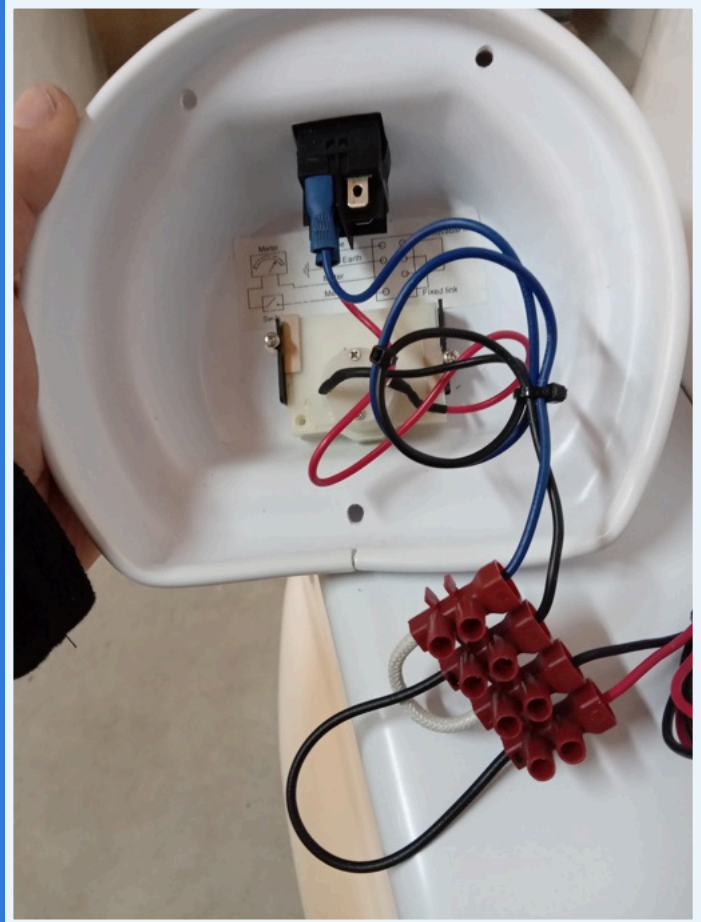

# DATA & MEASUREMENTS

Model	Flow l/min	System Volume m <sup>3</sup> LTHW	System Volume m <sup>3</sup> CWS	Connection	Height mm	Diameter mm	Dry Weight (kg)	Wet Weight (kg)
P120	100	120	85	DN40	1337	930	222	722
P220	160	220	155	DN40	1838	930	242	1042
P300	200	300	220	DN50	2088	930	260	1260
P600	400	600	440	DN65	2334	1280	510	2510
P900	600	900	660	DN80	2484	1610	750	3750
P1200	800	1200	880	DN100	2183	1910	950	4950
P1500	1000	1500	1100	DN100	2683	1910	1200	6200

**Note: Talk to us for systems that operate at higher pressures or higher temperatures.**



# DATA & MEASUREMENTS

## PROTECTOR P120-P1500 DATA

**Design Pressure** – PN10

**Max Temperature** - 90°C

**Design Code** – ART. 4.3 - 2014/68/UE (PED)

## MATERIALS

**Filter House:** Stainless steel AISI 304

**SS Micron Filter:** Stainless steel AISI 316L

**Gasket:** EPDM

**Manometer:** Stainless steel

**Anodes:** Magnesium

**Magnet:** Neodymium

**Tank:** Stainless steel INOX 304

**Insulation:** Polyurethane rigid foam , HSFC-free

**External finish:** PVC

## Options available

- 16 bar operating pressure.
- 110°C operating pressure but tank will be uninsulated.
- Inlet on right
- Optional filtration down to 25 micron
- Digital sensors on external filter for connection to the BMS.

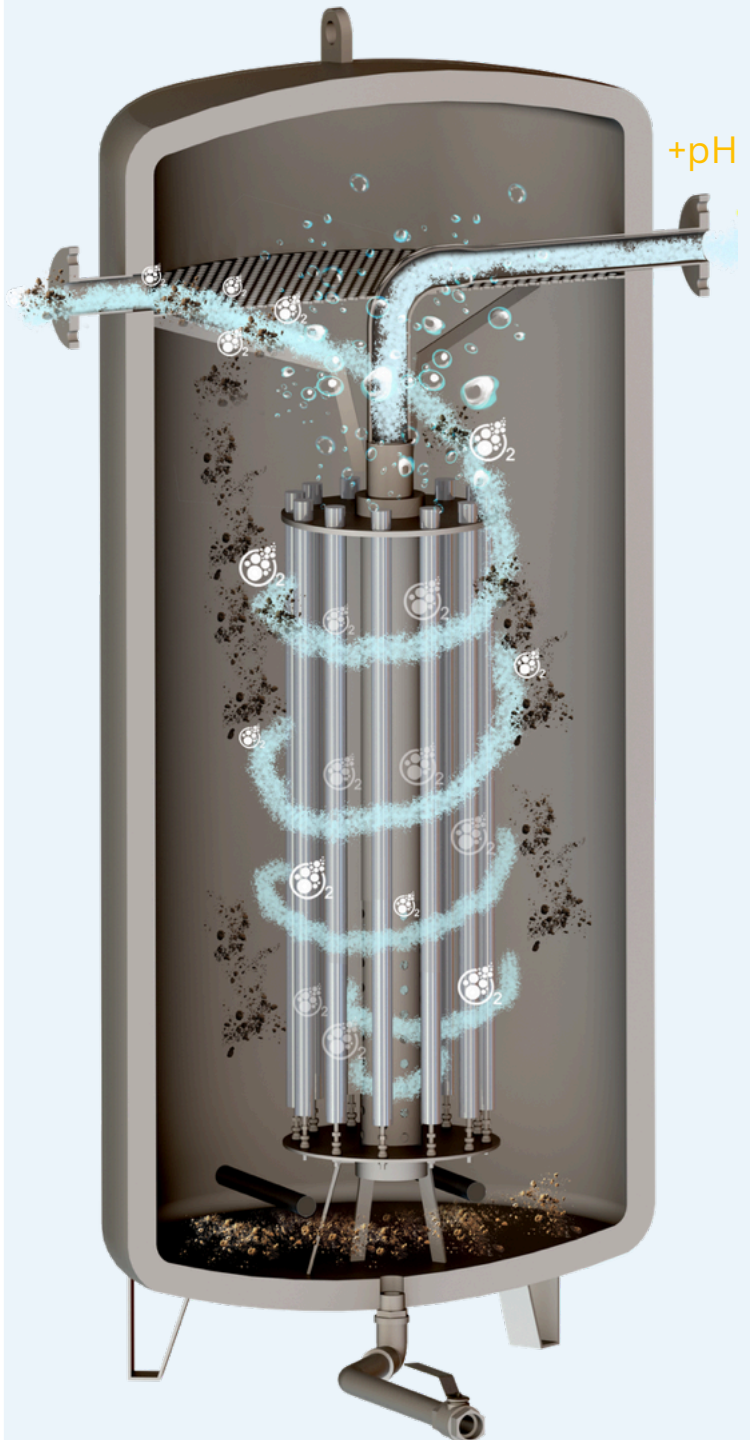
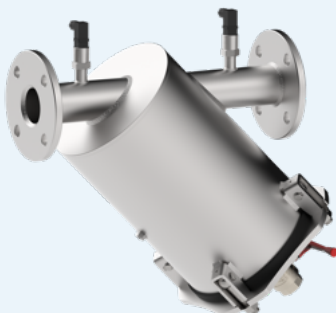

**Note:** Talk to us for systems that operate at higher pressures or higher temperatures.



# DATA & MEASUREMENTS

## PROTECTOR MEASUREMENTS

Unit	Height (A)	Diameter (B)	Connection or Flange (C)	Distance between flange (E)	Depth from Manhole (F)
P120	1337	930	DN40	1130	1160
P220	1838	930	DN40	1130	1160
P300	2088	930	DN50	1130	1160
P600	2334	1280	DN65	1450	1405
P900	2484	1610	DN80	1700	1725
P1200	2183	1910	DN100	2060	2100
P1500	2683	1910	DN100	2060	2100

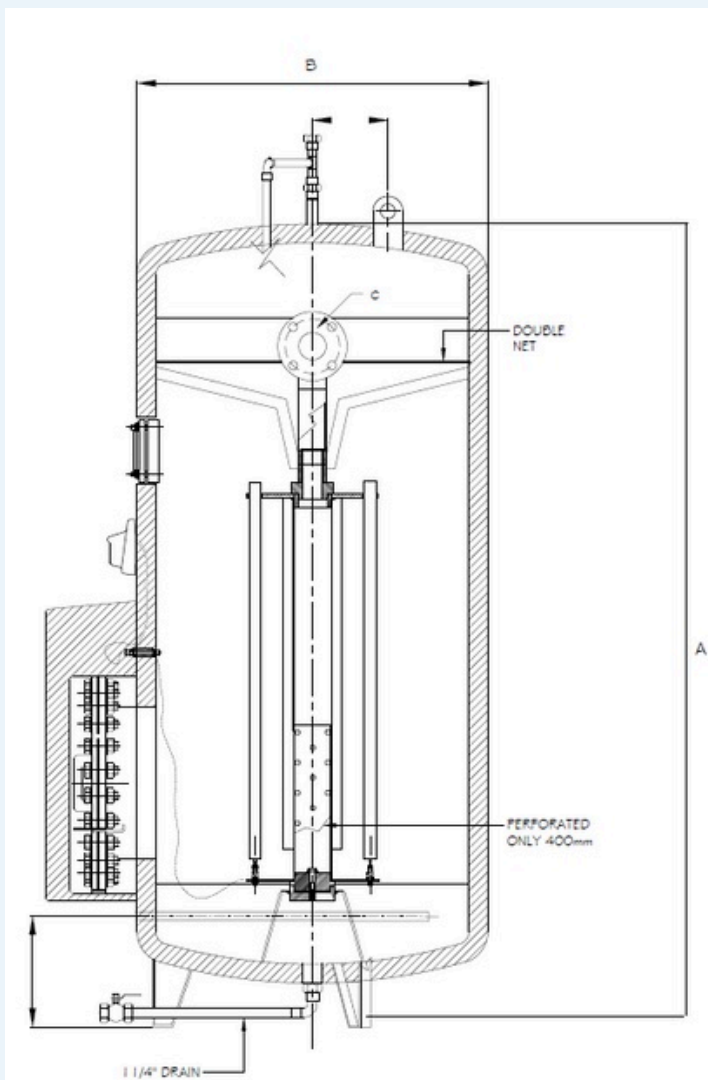

# DATA & MEASUREMENTS

## PROTECTOR MEASUREMENTS

Unit	Height (A)	Diameter (B)	Connection or Flange (C)	Distance between flange (E)	Depth from Manhole (F)
P120	1337	930	DN40	1130	1160
P220	1838	930	DN40	1130	1160
P300	2088	930	DN50	1130	1160
P600	2334	1280	DN65	1450	1405
P900	2484	1610	DN80	1700	1725
P1200	2183	1910	DN100	2060	2100
P1500	2683	1910	DN100	2060	2100

Unit	Filter Dimensions
P120	378 x 394
P220	378 x 394
P300	422 x 470
P600	476 x 490
P900	496 x 600
P1200	641 x 597
P1500	641 x 597

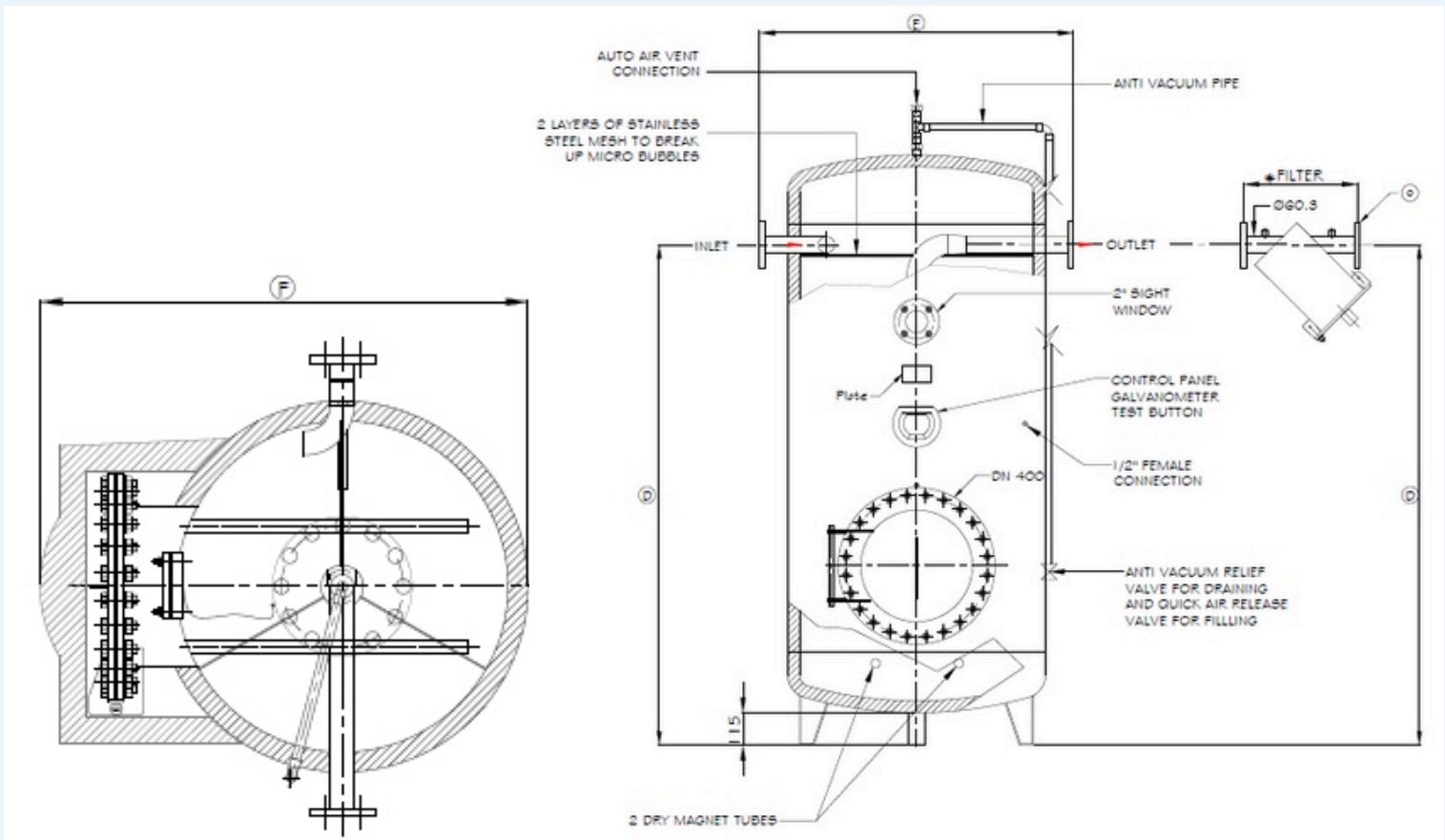

# MAINTENANCE

## ANALOGUE GALVANOMETER & PUSH BUTTON

The analogue galvanometer shows the galvanic current in milliamps between the anodes and the cathode (the tank body), with the system water being the medium.

The analogue galvanometer is always in a continuous reading position ; when the switch is pressed, the instrument is short circuited and shows little or no reading. This function is only for testing the analogue meter itself.

Pure water is non conducting, therefore the more impurities and oxygen in the water the more current will flow between the anode and the cathode.

When the water quality improves, the current diminishes and may measure even as low as 0.2 to 0.3 milliamps when the system water is fully passive.

The Protector unit system is self-regulating, the anode automatically works harder with corrosive water than with water that is no longer reactive.

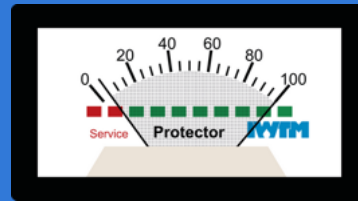

The needle swing lies between 10% and 100%.

This is the normal operating region. The lower the reading, the less the anode needs to work, and the less impurities are in the system water.



The needle always reads 100%.

The anode is working hard.

If the needle remains in this position for longer than one heating season, the Protector unit may be undersized for the system.

Action: check the system volume



The needle lies continuously close to the red region ;

the needle still drops to the minimum reading when you press the test button however, the anode no longer needs to work because the chemical reactions in the water have finished, the anode can no longer work because it is coated in a barrier layer or the anode may be close to expiring and needs replacing.

# MAINTENANCE

## ANALOGUE GALVANOMETER & PUSH BUTTON

Action: remove the sludge from the Protector and fill with fresh water. Keep the isolation valves closed for a day to hold the more corrosive fresh water inside the Protector.

After a day, if the operating meter shows a higher reading, everything is operating correctly, and the Protector unit can be put back into operation. Otherwise, you need to open the manway to inspect the appliance.

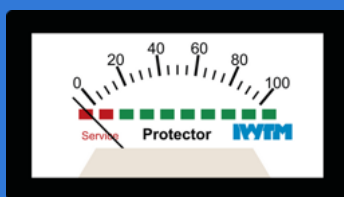

**The needle drops into the red region within a few weeks.**

The anode is spent or coated in a barrier layer or the Protector is isolated from the system and no water is circulating through it.

Action: check circulation or open the appliance and clean or replace the anodes.

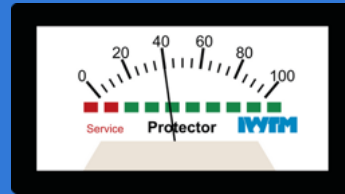

**The meter continues to show a constant reading over a long period.**

The operating meter might be faulty.

Action: press the test button to check the meter (the needle should drop to the left).

**If there is no change in the needle position, the meter is probably faulty.**

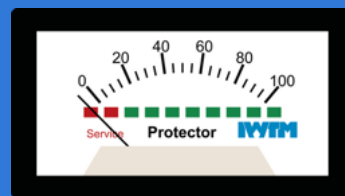

**After servicing, if the indicator position is hard left in the red.**

If the anode wires are connected wrong, it will create a short circuit and the swing meter will sit in the red zone and will raise up slightly when pressing the test button. Action: change the two connection wires around on the anode and the earth.

While the Protector is increasing the pH and scavenging oxygen the water gets less aggressive and the current will decrease and stabilise. (normally from 4-15 mA). If some chlorides or sulphates should interfere, resulting in higher conductivity or increased oxygen (feed water), the ampere & output will increase again.

# MAINTENANCE

## DRAINING

The Protector unit may need to be blown down frequently ; how often is dependent on the water quality.

The higher the starting conductivity level, the more sludge there'll be, resulting in a need for more frequent draining.

This is to flush out the sludge and particles that have been collected in the bottom of the tank, from the magnet trap and the cyclone filtration.



# MAINTENANCE

The Protector P120 to P1500 has an inspection window sight glass to enable you to inspect the anodes without opening the unit up and removing the need to carry out a full inspection service.

If the anodes are in good condition then you only need to carry out a blow down service

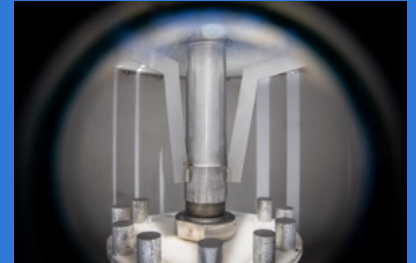
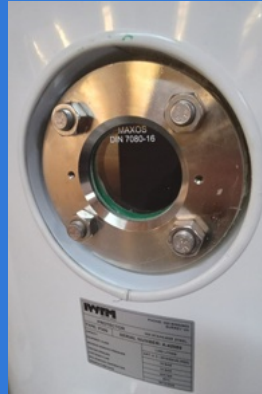

## BLOW DOWN SERVICE

1) Check the differential pressure gauges on the filter on the outlet, if there is no or little difference then the filter does not need cleaning.



2) Turn off the Protector pump

3) Isolate the outlet valve

4) Withdraw the magnets from the front of the Protector and set them safely aside -

**Do not handle the magnets if you have a pacemaker.**

5) Leave the water to settle for at least 5 minutes so any collected magnetite can fall to the base of the tank ready to drain.

6) Connect a hose to the drain connection and run the hose to a drain or bucket, ideally you want to see the debris that is discharged so you are aware of what is being collected as part of the cleaning process



7) Open the drain valve until the hose is running clear of solids and debris

8) Close off valve

9) Connect a hose to the drain of the external filter and run the hose to a drain or bucket



10) Open the drain valve until the hose is running clear of solids and debris

11) Close off the drain valve

12) Replace the magnets

13) Open the outlet valve and turn on the pump



# MAINTENANCE

## BLOW DOWN AND FILTER SERVICE

- 1) If there is a differential pressure across the filter then the filter will need removing and cleaning to do this you will need to isolate both the inlet and outlet valves of the Protector
- 2) Turn off the Protector pump
- 3) Close off the inlet and outlet isolation valves
- 4) Withdraw the magnets from the front of the Protector and set them safely aside -

**Do not handle the magnets if you have a pacemaker.**

- 5) Leave the water to settle for at least 5 minutes so any collected magnetite can fall the base of the tank ready to drain.
- 6) Connect a hose to the drain connection and run the hose to a drain or bucket, ideally you want to see the debris that is discharged so you are aware of what is being collected as part of the cleaning process
- 7) Open the drain valve slightly whilst at the same time opening the anti vacuum/air inlet valve that is connected to the top of the tank and the AAV connection. 
- 8) Open the drain valve until the hose is running clear of solids and debris
- 9) Close off the drain valve and leave the anti vacuum valve open at this stage
- 10) Connect a hose to the drain of the external filter and run the hose to a drain or bucket until the water stops
- 11) Open the drain valve until the hose is running clear of solids and debris
- 12) Connect a hose to the drain of the external filter and run the hose to a drain or bucket
- 13) When the drain has stopped you can then undo the filter eye bolts
- 14) Remove the internal filter basket and wash the basket
- 15) Replace the clean basket
- 16) Re-assemble in reverse order, closing all drain valves.
- 17) Leaving the outlet valve closed, open the inlet valve.
- 18) Connect a hose to the anti vacuum/air release valve and open until water runs freely when the tank is full.
- 19) Replace the magnets
- 20) When the final air is released from the AAV the outlet valve can be opened and the pump turned back on





# MAINTENANCE

## FULL INSPECTION SERVICE

Ideally before working on the Protector P120 to P1500 range isolate the service valves the day before to allow the tank to cool down.

Before carrying out the full service ensure you have a spare gasket for the manway cover, the sight glass gasket if you are going to clean this also, and the spare anodes.

*Note: Where it is practical to do so the good quality water that is drained off can be collected and used to refill the Protector at the end of the service - This procedure is not covered in this manual as the practicalities of this operation will be dependant on individual site conditions - It is however something that IWTM encourage to conserve water.*

- 1) Turn off the Protector pump
- 2) Close off the inlet and outlet isolation valves
- 3) Withdraw the magnets from the front of the Protector and set them safely aside - **Do not handle the magnets if you have a pacemaker.**
- 4) Leave the water to settle for at least 5 minutes so any collected magnetite can fall the base of the tank ready to drain.
- 5) Connect a hose to the drain connection and run the hose to a drain or bucket, ideally you want to see the debris that is discharged so you are aware of what is being collected as part of the cleaning process.
- 6) Open the drain valve slightly whilst at the same time opening the anti vacuum/air inlet valve that is connected to the top of the tank and the AAV connection



- 7) Open the drain valve until the tank is empty
- 8) If the sight glass needs cleaning unbolt the flange
- 9) Remove the sight glass clean it and replace the glass and flange using a new gasket set
- 10) Remove the manway insulation cover and set aside



- 11) Undo and remove the manway bolts using a 30mm spanner and 30mm socket, then open the door on the hinge



- 12) Now you have access to the anodes and carousel

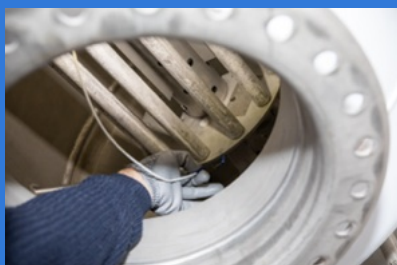

- 13) Disconnect the anode carousel cable and move aside.

- 14) Remove the central anode by unscrewing it either manually or you may need to use grips



# MAINTENANCE

## FULL INSPECTION SERVICE

15) Lift the anode upwards and tilt the bottom towards you to remove it through the manway



16) Remove the anode

17) Remove the carousel retaining pin to enable rotation of the carousel.



18) Remove all remaining anodes

19) Once all the anodes are removed wash down the inside of the tank and the carousel with a hose



20) Replace the anodes one at a time leaving the one closest to the locking pin until last.

21) Insert the anodes in the same way you removed them but in reverse

22) Angle the anode to get it inside the tank, then lower it down and then guide it upwards into the upper anode guide



23) Lower the anode and locate it and screw it into the carousel thread



24) Locate the carousel locking pin

25) Insert the last anode

26) Reconnect the anode carousel cable

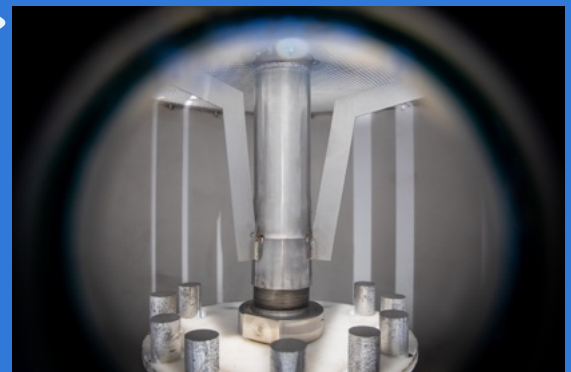

27) Make sure the manway flange is clean and hold the new gasket in place with a few bolts as shown



28) Close the manway guiding the bolts in to place

# MAINTENANCE

## FULL INSPECTION SERVICE

- 29) Tighten the nuts and bolts using the rotation procedure as per the tightening diagram
- 30) Leaving the outlet valve closed open the inlet valve
- 31) Connect a hose to the anti vacuum/air release valve and open until water runs freely when the tank is full.
- 32) When the final air is released from the AAV check the integrity of the manway seal
- 33) Check operation of the galvanometer
- 34) Replace the magnets
- 35) Now the outlet valve can be opened and the pump turned back on
- 36) Replace the manway insulation cover.

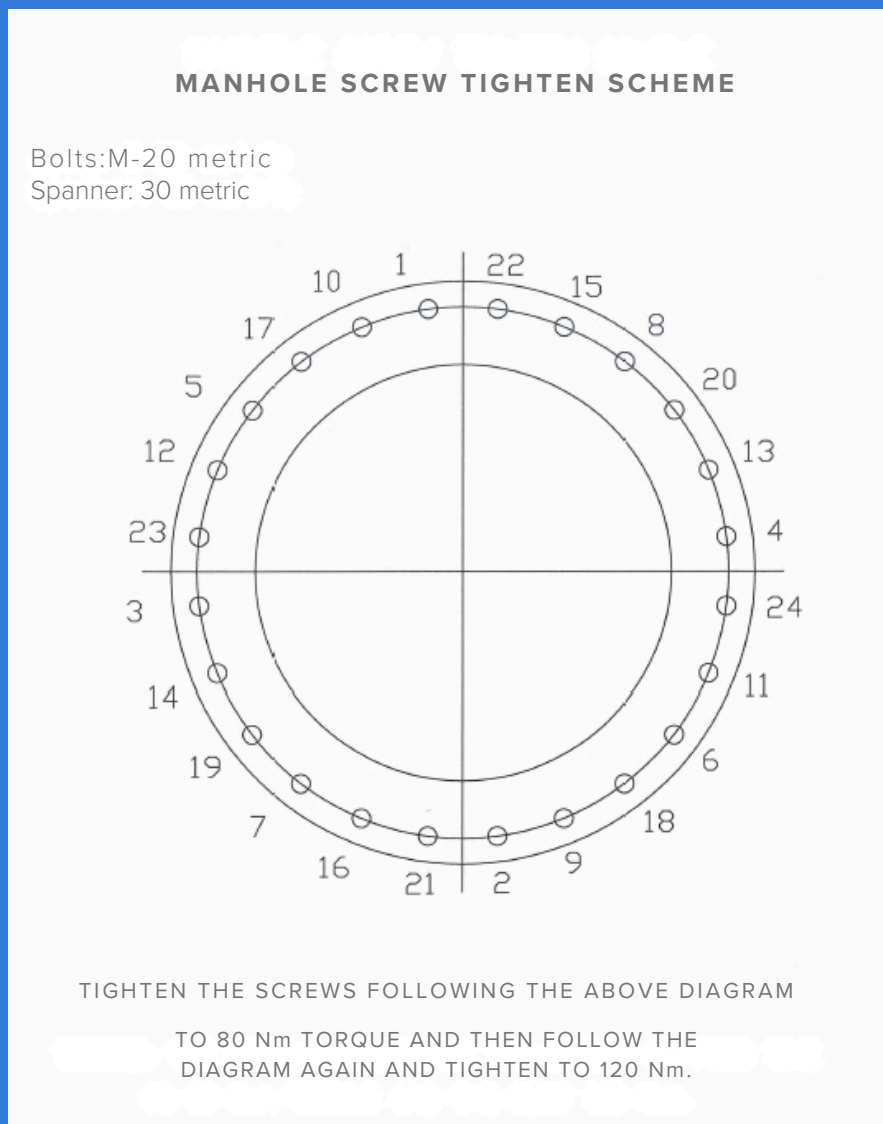

# ACCESSORIES

Part No.	Description
<b>Complete Units</b>	
300010	Protector P120
300020	Protector P220
300030	Protector P300
300040	Protector P600
300050	Protector P900
300060	Protector P1200
300070	Protector P1500
<b>Anodes</b>	
101563	P120 anodes. (12 anodes)
101565	<b>P220 - P1500 Anodes.</b> <i>Number of anodes as follows: P220 (9), P300 (12), P600 (24), P900 (36), P1200 (48), P1500 (60)</i>
<b>Gaskets</b>	
300101	Sight glass gasket (pair)
300102	Manway gasket (pair)
<b>Spare Parts</b>	
501500	AIR VENT CALLEFFI MAXCAL
100078	ANALOGUE INDICATOR
<b>Filters</b>	
AMCRT0101	2LAY FILTERKIT SIZE 1, 110MM (P120 , P220)
AMCRT0035	2LAY FILTERKIT SIZE 6, 110MM (P300, P600)
AMCRT0039	2LAY FILTERKIT SIZE 8, 110MM (P900, P1200, P1500)



# Environmental Culture Change

*be a part of it*

clean | protect | prevent







Founded in 1992, IWTM have been working with chemical free water treatment using electrochemistry for over 30 years and have offices in Norway, UK, Finland, Sweden, Canada, USA and a worldwide presence in the Marine sector.

We have developed models specifically suited to the higher demands of the marine industry operating at higher pressures and higher temperatures.

The marine products are provided worldwide on the world's largest cruise ships working with the leading operators in this sector.

Having secured DNV approval in 2003, we are still the only chemical free water treatment manufacturer to have this certification and approval. DNV is a globally leading quality assurance and risk management company operating in more than 100 countries.

The IWTM Protector™ is our most recently developed product. The Protector range is now available to our land-based customers.

Version 1: August 2024

*In line with continued product development we reserve the right to make any changes to this document without any given notice.*

# PROTECTOR

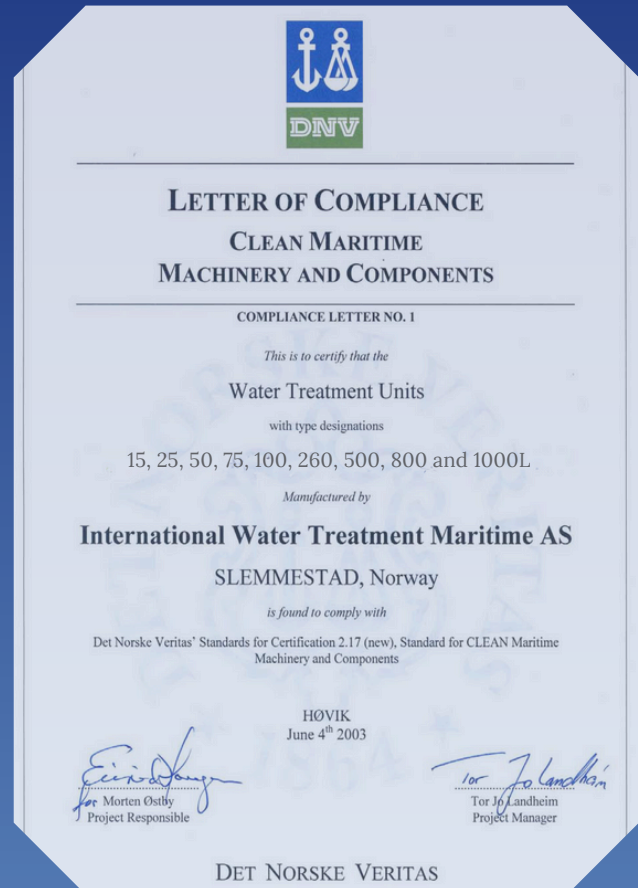

SUTTON BUSINESS CENTRE  
RESTMOR WAY  
WALLINGTON SM6 7AH

WWW.IWTM-UK.COM  
T: +44 208 255 2903  
E: INFO@IWTM-UK.COM